

Intelligent Air Operated Diaphragm Pumps appendix

edition 2017 rev 1



This manual is an appendix. Use it together with PE & PTFE, Metal or Sanitary AODD IOM manual !!!

(depends on the product series)

Read this manual carefully,
before installation and operation of the pump



Plastic series:

TC50

TC100

TC200

TC400

Metal series:

TC70

TC120

TC220

TC420

Sanitary series:

TC80

TC125

TC225

TC425

Powered by



LOW ENERGY AIR PUMP TECHNOLOGY

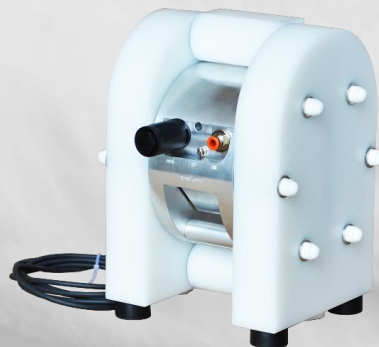

CONTENTS

0. GENERAL	5
0.1. Introduction	5
0.2. Warning symbols	5
0.3. Qualification and training of personnel	5
1. INSTALLATION	6
1.1. Health and safety	6
1.1.1. Protection.....	6
1.1.2. Electrical connections.....	6
1.1.3. Explosion hazardous environments – ATEX.....	6
1.1.4. Air pressure	6
1.2. Air connection.....	6
1.2.1. Internal Pilot (IP) / External Pilot (EP)	7
1.2.2. Air treatment system.....	9
1.3. Recommended installations.....	9
1.3.1. Flooded	9
1.3.2. Self-priming	9
1.3.3. Submerged	10
1.4. Intelligent control module electric scheme.....	10
2. OPERATION.....	11
2.1. Before starting the pump.....	11
2.2. Pump stopping	11
3. MAINTENANCE	12
3.1. Routine inspection	12
3.2. Complete inspection	12
3.3. Location of faults	13
3.4. T50/T70/T80 - Disassembly of the pump.....	14
3.4.1. Before the disassembly procedure.....	14
3.4.2. Disassembly procedure	14
3.4.3. Removing the air valve.....	16
3.4.4. Detaching the Intelligent control module	16
3.5. T50/T70/T80 – Assembly of the pump	17
3.5.1. Assembly of the air valve	17
3.5.2. Assembly of the diaphragm shaft.	18
3.5.3. Test run	19
3.6. T100 – T425 – Disassembly of the centerblock	20

CONTENTS

3.6.1.	Before the disassembly procedure.....	20
3.6.2.	Disassembly procedure	20
3.6.3.	Removing the muffler	22
3.6.4.	Detaching the Intelligent control module	22
3.6.5.	Removing the air valve.....	23
3.7.	T100 - 425 – Assembly procedure.....	24
3.7.1.	Assembly of the centerblock.....	24
3.7.2.	Assembly of the air valve	25
3.7.3.	Test run	27
4.	SPARE PARTS	28
4.1.	TC50, TC70, T80: Intelligent pump Centerblock – Spare parts drawing	28
4.2.	TC50, TC70, TC80: Intelligent pump Centerblock – Spare parts list	28
4.3.	TC100, TC120, TC125: Intelligent pump Centerblock – Spare parts drawing	29
4.4.	TC100, TC120, TC125: Intelligent pump Centerblock – Spare parts list.....	29
4.5.	TC200, TC220, TC225: Intelligent pump Centerblock – Spare parts drawing	31
4.6.	TC200, TC220, TC225: Intelligent pump Centerblock – Spare parts list.....	31
4.7.	TC400, TC420, TC425: Intelligent pump Centerblock – Spare parts drawing	32
4.8.	TC400, TC420, TC425: Intelligent pump Centerblock – Spare parts list.....	32
4.9.	Stocking recommendation.....	33
5.	WARRANTY	34
5.1.	Warranty form.....	34
5.2.	Returning parts	35
5.3.	Warranty	35

EC declaration of conformity

Machinery directive 2006/42/EC

Pressure equipment directive 97/23/EC, Category I

Tapflo AB declares that:

Product name: Air operated diaphragm pumps
Models: T...

is in conformity with the essential health and safety requirements and technical construction file requirements of the EC Machinery directive 2006/42/EC,

and is in conformity with the Pressure Equipment Directive (PED) 97/23/EC, Category I.

Manufactured by Tapflo Sp. z o. o., Poland for:

Tapflo AB
Filaregatan 4
S-442 34 Kungälv
Sweden

Tapflo AB, January 2nd 2013



Håkan Ekstrand
Managing director

0. GENERAL

0. GENERAL

0.1. Introduction

The Tapflo Intelligent Air Operated Diaphragm Pump range is a complete series of pumps for industrial and sanitary applications. The pumps are designed to be safe, simple and easy to use and maintain. The construction has no rotating parts. The pumps are suitable for almost all different chemicals used by the industry today.

With proper attention to maintenance, Tapflo Pumps will give efficient and trouble free operation. This instruction manual will familiarise operators with detailed information about installing, operating and maintaining of the pump.

0.2. Warning symbols

The following warning symbols are present in this instruction manual. This is what they say:



This symbol stands next to all safety instructions in this instruction manual where danger to life and limb may occur. Observe these instructions and proceed with utmost caution in these situations. Inform also other users of all safety instructions. In addition to the instructions in this instruction manual, the general safety and accident prevention regulations must be observed.



This signal stands at points in this instruction manual of particular importance for compliance with regulations and directives, for correct work flow and for the prevention of damage to and destruction of the complete dampener or its subassemblies.



This symbol signals possible danger caused by the presence of electric fields or live wires.

0.3. Qualification and training of personnel



The personnel in charge of installation, operation and maintenance of the pumps we produce must be qualified to carry out the operations described in this manual. Tapflo shall not be held responsible for the training level of personnel and for the fact that they are not fully aware of the contents of this manual.

1. INSTALLATION

1. INSTALLATION

1.1. Health and safety

The pump must be installed according to local and national safety rules.



The pumps are constructed for particular applications. Do not use the pump on applications different from that for which it was sold without consulting us to ascertain its suitability.

1.1.1. Protection



In the interest of health and safety it is essential to wear protective clothing and safety goggles when operating, and/or working in the vicinity of Tapflo pumps.

1.1.2. Electrical connections



The system must be installed by suitably trained personnel in accordance with the prevailing code of practice.

Efficient installation, inspection and maintenance of the system is essential.

1.1.3. Explosion hazardous environments – ATEX



The Intelligent pump is not allowed to operate in environments where is danger of explosion.

1.1.4. Air pressure



The maximum air pressure for Tapflo pumps is 8 bar. Higher air pressure than 8 bar can damage the pump and may cause injury to personnel in vicinity of the pump. If you intend to apply a higher air pressure than 8 bar, please consult us.

1.2. Air connection

Screw the air hose into the air intake on the centerblock of the pump with for example a quick release coupling. For best efficiency, use the same hose diameter as the internal diameter of the connection on the air intake.

1. INSTALLATION

1.2.1. Internal Pilot (IP) / External Pilot (EP)



The Intelligent pump can operate in two settings, Internal and External Pilot. In standard conditions the pump runs with a single air supply from 0.1 bar, deriving an air supply to the Intelligent control module from the Internal Pilot - main air supply. In some applications however, there may be a need to use the External Pilot - a separate (additional) air supply to the Intelligent module. The EP assist in moving the air motor in application of:

- Extremely low pressure - it supports shifting of the air valve;
- High pressure of 8 bar - to create an air cushion preventing the air valve from being fired backwards and forwards.

NOTE! External Pilot air supply should be within the range of 1-8 bar. Despite the high range, keep in mind that, ***the lower the better.***

View of pump air ports (TC50/TC70/TC80)

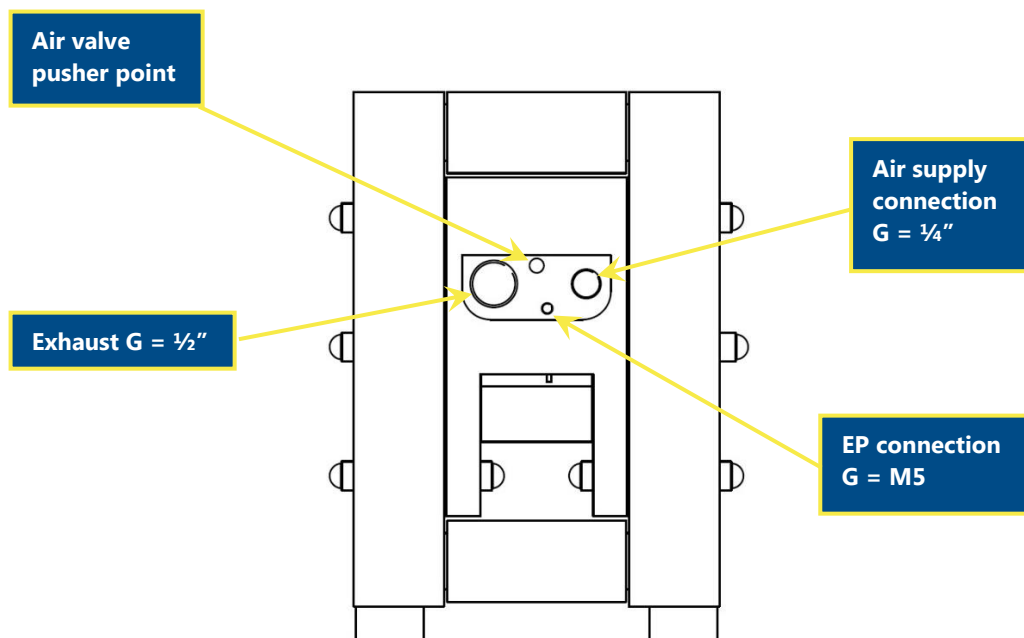

View of pump air ports (T100 - T425)

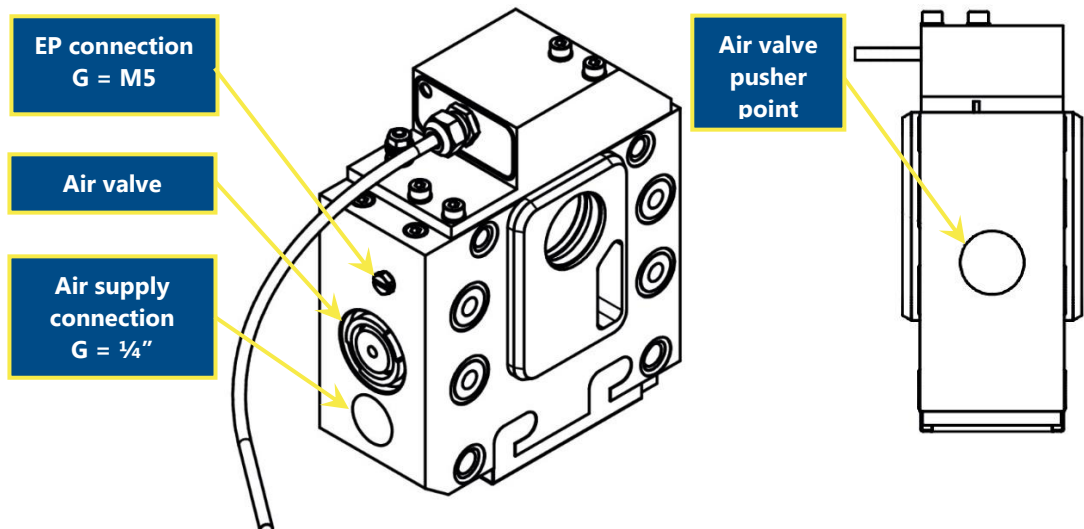

1. INSTALLATION

Configuration of IP/EP

- **External Pilot:** the pump is normally provide with IP configuration. To configure EP, remove the Intelligent control module (see chapter 3.4.4 and 3.6.4 "Detaching the Intelligent control module") and invert the gasket as it is shown in the picture below.

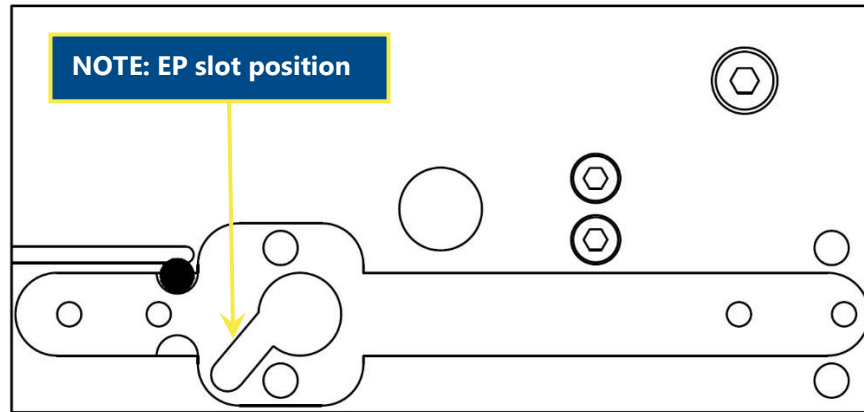

Then, reattach the control module by simply reversing the steps mentioned in chapter 3.4.4 and 3.6.4 "Detaching the Intelligent control module". Next step is to remove EP connection plug (see drawing - "View of pump air ports") and connect additional air supply to the EP connection by screwing quick release coupling.

- **Internal Pilot:** to configure IP invert the gasket as it is shown on picture below, following the same steps as for EP, then refit the EP connection plug.

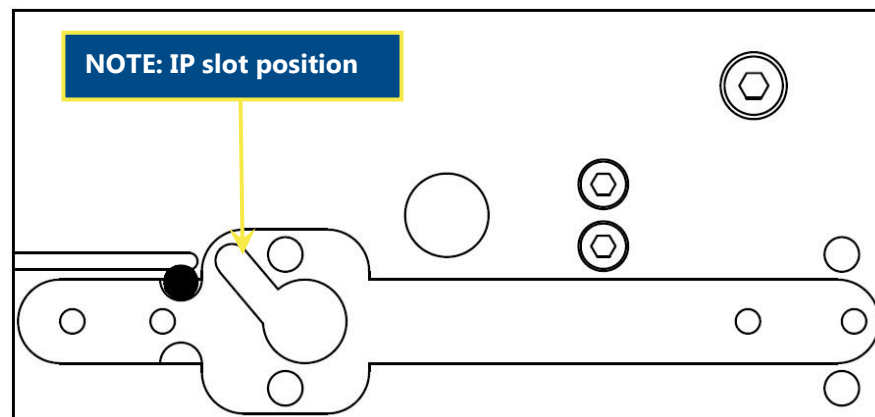

NOTE! Remember to screw in the EP connection plug when using IP mode.

1. INSTALLATION

1.2.2. Air treatment system



The air valve is constructed for oil-free air. Lubrication of the air, especially with water, is **not allowed**. Maximum air pressure is 8 bar. As prevention purpose, a filtration of the air by means of a 5 micron filter or finer is recommended. Recommended air quality according to PN-ISO8573-1:2010 is particles class 6, water class 4 and oil class 4. Dirt in the air can under unfortunate circumstances be the cause of a breakdown.

To facilitate the operation of the pump we recommend an air treatment system connected to the air supply. These components should be included:

- 1) Regulator to adjust the air pressure;
- 2) Manometer to read the actual pressure;
- 3) Needle valve to adjust the air flow (especially when operating the pump in the lower range of performance);
- 4) Filter.

These components are included in Tapflo's **Air treatment system** which can be ordered from directly us.

1.3. Recommended installations

The Tapflo pump is flexible in the way you are able to install it. The in- and outlet ports can be rotated more than 180° to fit various piping systems.

1.3.1. Flooded

The piping system is designed with a positive suction head. This is the best way of installation where it is necessary to completely empty all liquid from the container, or where viscous (thick) products are transferred.



NOTE! Do not exceed 0.7 bar suction pressure! Higher pressure may cause premature diaphragm failure and irregular pump operation.

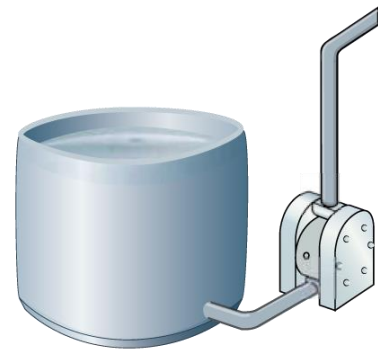

1.3.2. Self-priming

The Tapflo pump is designed to pull a high vacuum. It is able to evacuate an empty suction pipe without any damage to the pump. The suction lift is up to 5 meters (16.4 ft.) from an empty suction pipe and up to 8 meters (26.2 ft.) from a wetted pipe. The suction capability depends on the pump size (see full *PE and PTFE diaphragm pumps IOM manual, chapter 5 "DATA"*).

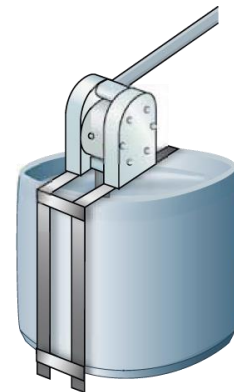

1. INSTALLATION

1.3.3. Submerged



Tapflo Intelligent pumps contains control module [97E – see chapter 4 “Spare parts ”], therefore submerging the pump is not allowed.

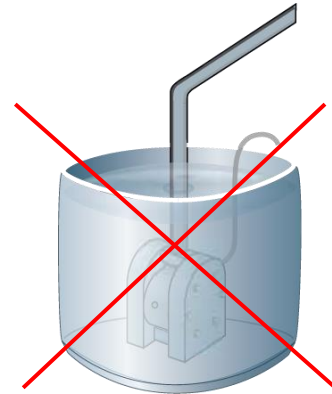

NOTE!

Even if all above safety instructions are met and complied with, there still exists a minor danger in the event of a leakage or mechanical damage of the pump. In such case the pumped product can emerge on sealing areas and connections.

1.4. Intelligent control module electric scheme



For proper operation the Tapflo Intelligent pump needs to be supplied with +24 VDC power. Connect the BROWN wire to +24 VDC and BLUE wire to 0 VDC (GND).

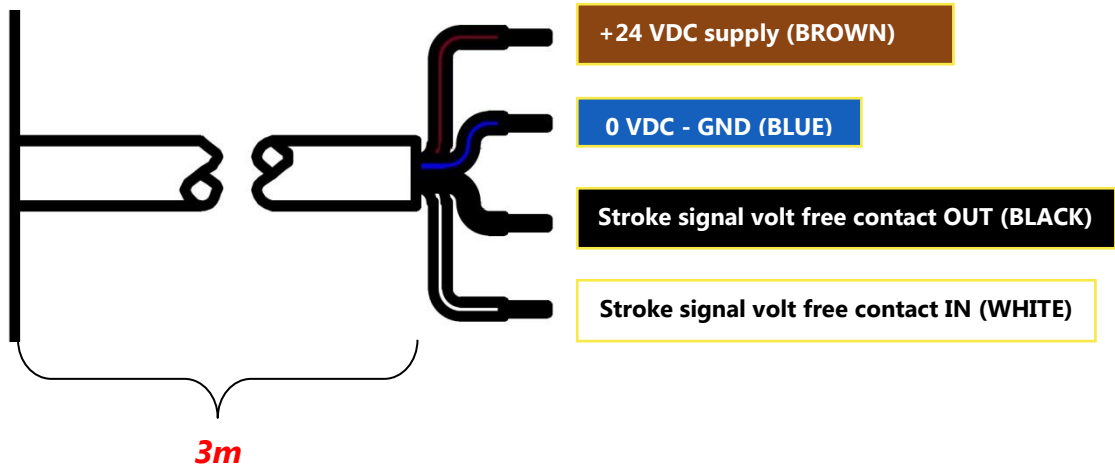

2. OPERATION

2. OPERATION

2.1. Before starting the pump



- Make sure the control module [97E – see chapter 4 “Spare parts”] is connected according to chapter 1.4 “Intelligent control module electric scheme”.
- READ carefully full *PE & PTFE, Metal or Sanitary AODD IOM manual**

**Depends on product series*

2.2. Pump stopping

The pump can be stopped in three ways:

- 1) By closing of the discharge valve. The pressure from the system will stop the pump automatically. The pump restarts easily when the valve is opened again.
NOTE! When using this method keep in mind that air must be supplied to the pump. This is essential to keep the diaphragms in balance what protects them from premature failure.
- 2) By cutting off the air supply.
NOTE! When using this method make sure that the discharge valve is opened to relief the pumps pressure.
- 3) By cutting 24 VDC supply to the control module [97E – see chapter 4 “Spare parts”]. The pump restarts when the voltage is supplied again.
NOTE! When using this method it is recommended to relief the pump of pressure – open the discharge valve and cut off the air supply.

3. MAINTENANCE

3. MAINTENANCE

3.1. Routine inspection



Frequent observation of the pump operation is recommended to detect problems

- 1) A change in sound of the running pump can be an indication of wearing parts (see chapter 3.4 "Location of faults" below).
- 2) Leaking liquid from the pump and changes of performance may also be detected. Routine inspections should be conducted frequently.
- 3) To avoid electrical shock attention should be paid to the control module cable insulation condition.



3.2. Complete inspection



The intervals for a complete inspection depend upon the operation conditions of the pump. The characteristics of the liquid, temperature, materials used in the pump and running time decide how often a complete inspection is necessary.

Nevertheless, Tapflo recommend to inspect the pump at least once a year. Parts from **KIT VAL** and **KIT LIQ** should be changed during inspection. See paragraph 5.3 for detailed KIT content.

If a problem has occurred, or if the pump is in need of a complete inspection, refer to chapters 3.3 "Location of faults" and 3.4 "Dismantling of the pump". You are of course warmly welcome to consult us for further help.

Parts that are subject to wear should be kept in stock, see our recommendations in chapter 4.3 "**Błąd! Nie można odnaleźć źródła odwołania.**".

3. MAINTENANCE

3.3. Location of faults

PROBLEM	POSSIBLE FAULT	POSSIBLE SOLUTION
The pump does not run	The air pressure is too low The air connection is blocked Muffler is blocked Air valve is defective Dirt in the pump chamber Diaphragm breakdown No power supply Disconnected electrical connections Wrong IP/EP mode	Increase air pressure via a filter-regulator Check / clean air supply connection Check / clean / replace muffler Clean / replace complete air valve Remove debris from the chambers Replace diaphragm Check electrical supply Check electrical connections Check if gasket position is correct for application (IP/EP)
The suction is bad	Suction connection is not tight Suction connection is blocked Muffler is blocked Valve balls are blocked or damaged Valve seats are worn Pump starts with high pressure Air in suction / discharge line Dry suction against discharge pressure	Tighten the suction line Clean suction line Check / clean / replace muffler Check dimensions and shape of valve balls Check dimensions and shape of valve seats Start the pump slowly (see chapter 2.2) Vent suction / discharge line Wet the pump / start without discharge pressure
The pump runs irregularly	Valve balls are blocked Sealing in centerblock Air valve is defective Diaphragm breakdown Valve seats are worn Icing on the muffler Wrong IP/EP mode Supply pressure too low	Check dimensions and shape of valve balls Replace sealing Clean / replace air valve Replace diaphragm Check dimensions and shape of valve seats Improve air quality (see chapters 1.7.1 and 2.2.2) For low pressure applications (<0.5 bar) convert to EP mode Increase supply pressure
Bad flow/pressure	Pressure fall in air supply Pressure losses on suction side Air supply / air valve leaking Suction or air connection blocked Muffler is blocked Valve ball worn or broken Valve seats are worn Air in liquid Diaphragm breakdown Icing on the muffler	Increase air pressure via a filter-regulator Check/change installation on suction side Check / repair / replace air supply / air valve Check / clean air supply / suction connection Check / clean / replace muffler Check dimensions and shape of valve balls Check dimensions and shape of valve seats Seal suction line; check / refill container Check / replace diaphragms Improve air quality (see chapters 1.7.1 and 2.2.2)
Liquid leaks from the pump	Screws on the housing not properly tightened O-rings on manifolds damaged Damaged diaphragm Tension / stress from the installation	Check tightening torques of the screws Replace O-rings Check / replace diaphragms, air valve and control module Adjust installation, eliminate stress, when using a dampener provide separate support for it (see dampener IOM manual).
Liquid comes out of the muffler	Diaphragm breakdown	Replace diaphragm, air valve and control module
Diaphragm breakdown	Wrong selection of material Too high pressure in the installation Long periods of dry running Too high pressure on suction side	Contact us for information on material selection Use air treatment system for protection When dry, run pump slowly (see chapter 2.2) Make sure there is pressure balance between the air and liquid side of the diaphragm
Air leaks around control module	Control module not fitted correctly Gasket missing	Check if fixing are tight Place the gasket

3. MAINTENANCE

3.4. T50/T70/T80 - Disassembly of the pump

The numbers put in brackets, refer to the part numbers in the spare part drawings and spare part lists in chapter 4 "*Źródło! Wynik nieprawidłowy dla tabeli.*".

3.4.1. Before the disassembly procedure



Be sure to drain all liquid from the pump. Cleanse or neutralize the pump thoroughly. Disconnect the power supply to control module, air supply and then the suction and discharge connections.

3.4.2. Disassembly procedure

NOTE! Example below shows disassemble procure of PE pump, however dismantling depends on product series!



Fig. 3.4.1
Unscrew the housing nuts [37] and washers [38].



Fig. 3.4.2
Lay down the pump on one side and lift one of the housings [11].



Fig. 3.4.3
Lift the loose manifolds [13] and centerblock [12] from the second housing [11]. Then carefully remove the pin screws [14].



Fig. 3.4.4
To remove the spacer sleeve [19], use a plastic rod and a hammer to knock it out.
NOTE! Be careful not to deform the spacer sleeve.

3. MAINTENANCE



Fig. 3.4.5

Insert our special tool or pin screw [14] into the orifice in the spacer sleeve [19], rotate it.

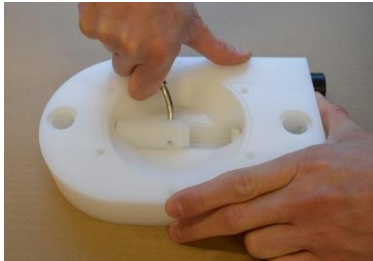

Fig. 3.4.6

Pull out the spacer sleeve [19].



Fig. 3.4.7

Pull out the lower sleeve [212], valve seat [222] and O-ring [43].

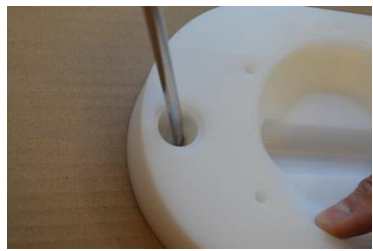

Fig. 3.4.8

Pull out the upper sleeve [202] alongside with the valve seat [222], O-ring [43] and the blocking pin [2021].

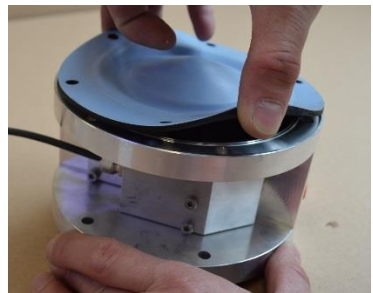

Fig. 3.4.9

Unscrew the diaphragm [15] from one side of the pump.

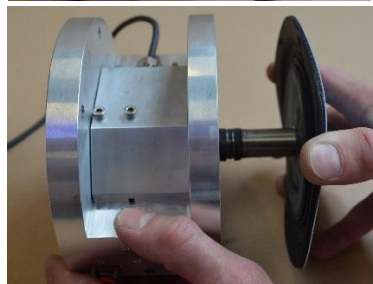

Fig. 3.4.10

Take out the second diaphragm [15] along with the shaft [16E]. Take care of the O-rings [36E].

3. MAINTENANCE

3.4.3. Removing the air valve

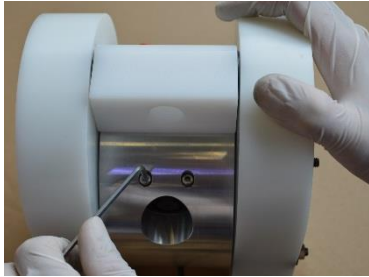

Fig. 3.4.11

Using Allen key remove both socket head cap screw [27E] from the centerblock [12E].



Fig. 3.4.12

The air valve assembly [61E] can be easily pushed out by hand using a rod with smooth tip or hex key as a drift. Insert the drift in to the air valve pusher hole (to locate the hole, see drawing in chapter 1.2.1. "View of pump air ports") and push the air valve out.

NOTE! Be careful not to damage the air valve assembly [61E]. Do not use rod with sharp tip.



Fig. 3.4.13

Preventively, with one hand block the air valve [61E] coming out from the other side of the centerblock [12E].

3.4.4. Detaching the Intelligent control module

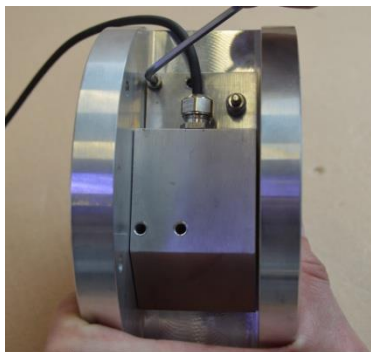

Fig. 3.4.14

Unscrew the module valve fixing screws 2 x [272E] and 2 x [273E] from the top of the centerblock [12E].



Fig. 3.4.15

Take out the control module [97E]. Take care of the sealing [971E].

The pump is now completely disassembled. Check all components for wear or damage and replace if necessary.

3. MAINTENANCE

3.5. T50/T70/T80 – Assembly of the pump

The assembly procedure is done in the reverse order to the disassembly.

Nevertheless there are a few things that you have to remember in order to assemble the pump correctly.

3.5.1. Assembly of the air valve

NOTE! Assembly should be proceed with the protecting gloves in order to prevent air valve from dust and dirt contamination.



Fig. 3.5.1

When putting the air valve [61E] into the centerblock [12E], remember to keep appropriate orientation.

NOTE! Although the air valve [61E] consist of a few loose components, it is a one device. Therefore do not change the order when pulling out of the box.



Fig. 3.5.2

Before assembly put few drops of the lubricant on the inside of the air valve hole.

NOTE! Use only strictly defined lubricant - Optimol Obeen UF2

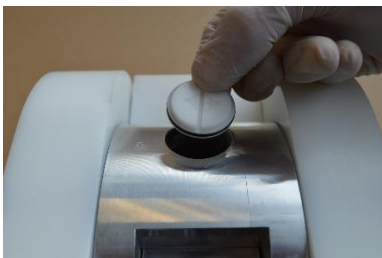

Fig. 3.5.3

Fit a white plastic part into the centerblock hole, with cutting faces towards to the opening of the air valve hole.



Fig. 3.5.4

Push the plastic part into the centerblock hole on short distance.



Fig. 3.5.5

Fit the main part of the air valve into the centerblock hole.

3. MAINTENANCE

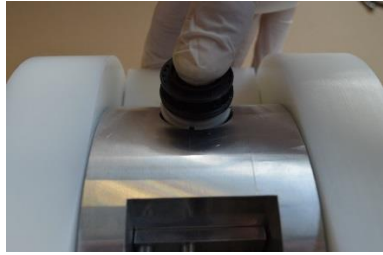

Fig. 3.5.6

Rotate the end cap to allow retaining it with screws [27E], then Press the assembly of the air valve [61E] to the very end of centerblock hole.



Fig. 3.5.7

Be careful to align the end cap as if incorrectly orientated the retaining [27E] screws cannot be inserted.

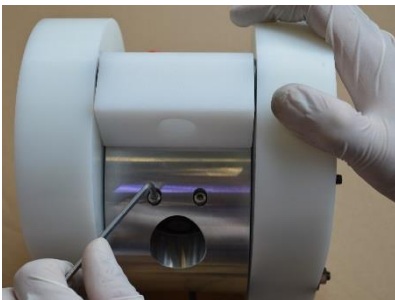

Fig. 3.5.8

Using Allen key, screw both socket cap screws [27E] to fix the air valve [61E].

3.5.2. Assembly of the diaphragm shaft.

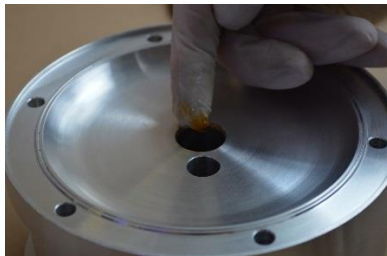

Fig. 3.5.9

Before assembly put small amount of lubricant onto the edges of the shaft hole and inside the hole.



Fig. 3.5.10

Also put small amount of lubricant onto the shaft [16E] incorporated O-ring.

3. MAINTENANCE

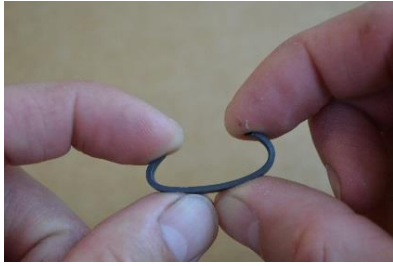

Fig. 3.5.11

Wear-ring [36E] is provided in the form of a flat strip, to give it a cylindrical shape, fold both ends as shown in the picture.



Fig. 3.5.12

Fit the wear-ring into the shaft [16E] groove.



Fig. 3.5.13

Insert diaphragm shaft [16E] into the centerblock hole. Squeezing the wear-ring push the diaphragm shaft [16E] until the wear-ring is fully covered.

NOTE! When inserting shaft [16E] be careful not to damage incorporated shaft O-ring. Insert the shaft [16E] vertically in the axis of the centerblock hole.



Fig. 3.5.14

Repeat above steps with second wear-ring.



Fig. 3.5.15

Before inserting the pin screws [14] remember to align axially bushing [1204E] holes with the diaphragm [15] and centerblock [12E] holes. Sometimes it is necessary to turn the diaphragm back a little bit in order to align the holes.

3.5.3. Test run



We recommend you to conduct a test run of the pump before installing it in the system, so no liquid gets wasted if the pump leaks or perhaps does not start accordingly to wrong assembly of the pump.

After a few weeks of operation retighten the nuts with appropriate torque [see full IOM manual].

3. MAINTENANCE

3.6. T100 – T425 – Disassembly of the centerblock

The numbers put in brackets, refer to the part numbers in the spare part drawings and spare part lists in chapter 4 *"Błąd! Wynik nieprawidłowy dla tabeli."*.

3.6.1. Before the disassembly procedure



Be sure to drain all liquid from the pump. Cleanse or neutralize the pump thoroughly. Disconnect the power supply to control module, air supply and then the suction and discharge connections.

3.6.2. Disassembly procedure



Fig. 3.6.1
Unscrew diaphragm [15] from both sides of the pump.



Fig. 3.6.2
Take out pin screws [14] and take care of the bushings [1204E]

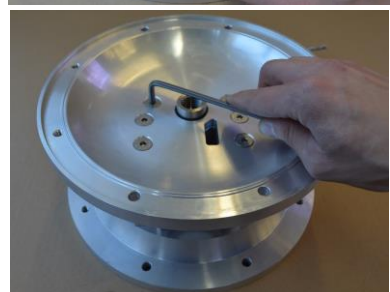

Fig. 3.6.3
Unscrew back plate retaining screws [1202E] and [1203E].

NOTE! Back plate retaining screws [1203E] appear only in size T400/T420/T424.

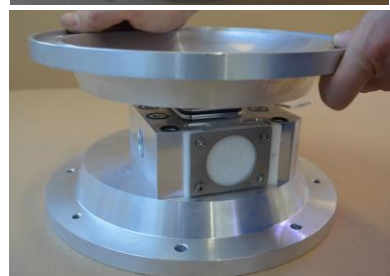

Fig. 3.6.4
Lift the diaphragm back plate [1201E].

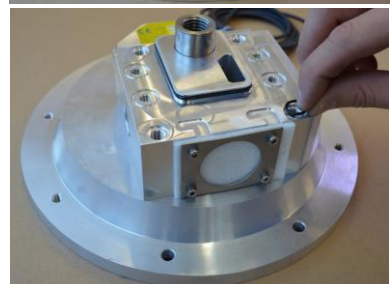

Fig. 3.6.5
Remove back plate O-rings [1211E], [1212E], [1213E].

3. MAINTENANCE

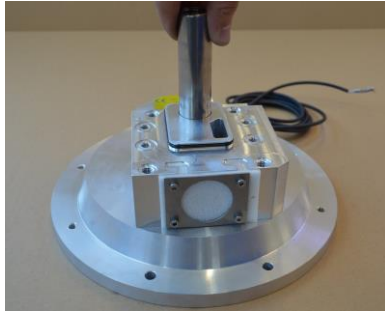

Fig. 3.6.6
Take out the diaphragm shaft [16E].

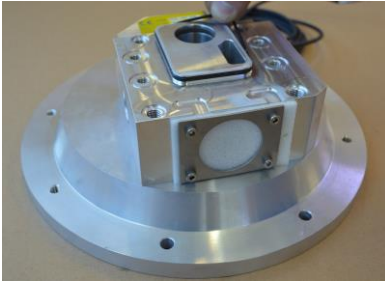

Fig. 3.6.7
Remove back plate square O-ring [1202E] from centerblock groove.

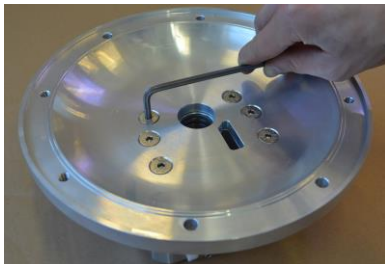

Fig. 3.6.8
Unscrew back plate retaining screws [1202E] and [1203E].

NOTE! Back plate retaining screws [1203E] appear only in size T400/T420/T424.



Fig. 3.6.9
Lift the diaphragms back plate [1201E].



Fig. 3.6.10
Remove back plate O-rings [1211E], [1212E], [1213E].



Fig. 3.6.11
Remove back plate square O-ring [1202E] from centerblock groove.

3. MAINTENANCE

3.6.3. Removing the muffler

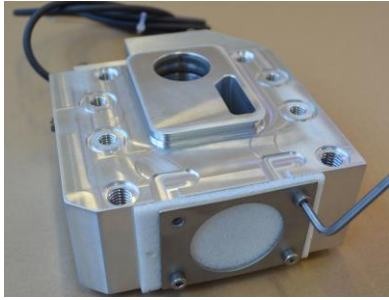

Fig. 3.6.12
Unscrew muffler retaining screw [252E].



Fig. 3.6.13
Take out the muffler [25E] together with retaining plate [251E].

3.6.4. Detaching the Intelligent control module

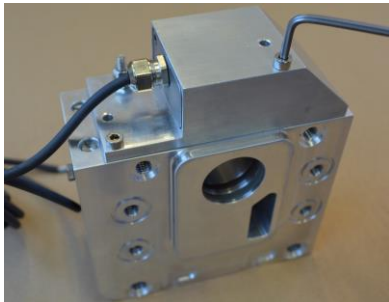

Fig. 3.6.14
Unscrew the module valve fixing screws 2 x [272E] and 2 x [273E] from the top of the centerblock [12E].



Fig. 3.6.15
Take out the control module [97E]. Take care of the sealing [971E].

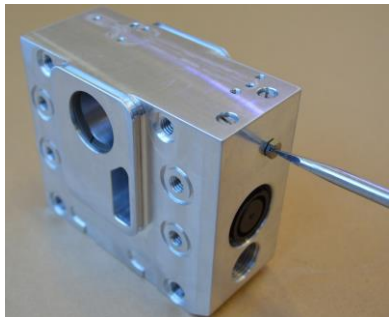

Fig. 3.6.16
Unscrew EP connection plug

NOTE! Only If you decided you to use External Pilot mode.

3. MAINTENANCE

3.6.5. Removing the air valve

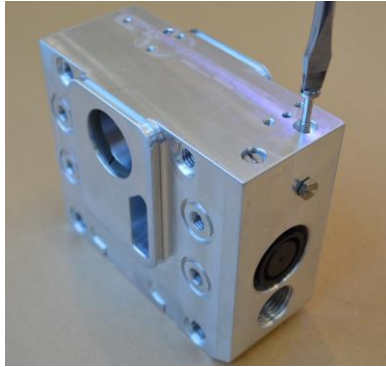

Fig. 3.6.17

Using flat-blade screwdriver remove both retaining screws [27E] from the centerblock [12E].



Fig. 3.6.18

The air valve assembly [61E] can be easily pushed out by hand using a rod with smooth tip or hex key as a drift. Insert the drift in to the air valve pusher hole (to locate the hole, see drawing in chapter 1.2.1. "View of pump air ports") and push the air valve out.

Preventively, with one hand block the air valve [61E] coming out from the other side of the centerblock [12E].

NOTE! Be careful not to damage the air valve assembly [61E]. Do not use rod with sharp tip.

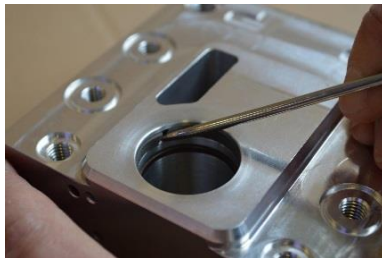

Fig. 3.6.19

By means of sharp tool remove 2 x cut wear-rings [361E] from the centerblock [12E] internal groove.

NOTE! Be careful not to scratch inside of the centerblock [12E].

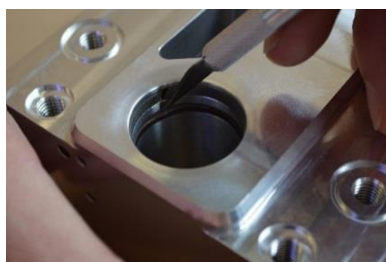

Fig. 3.6.20

By means of sharp tool remove back-up O-ring [362E] and remember to take care of O-ring [47E] placed under the wear-ring [362E] as shown in the picture.

NOTE! Be careful not to scratch inside of the centerblock [12E].

3. MAINTENANCE

3.7. T100 - 425 – Assembly procedure

The assembly procedure is done in the reverse order to the disassembly. Nevertheless there are a few things that you have to remember in order to assemble the pump correctly.

3.7.1. Assembly of the centerblock

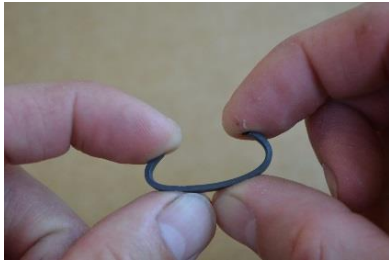

Fig. 3.7.1

Wear-ring [361E] is provided in the form of a flat strip, to give it a cylindrical shape, fold both ends as shown in the picture.



Fig. 3.7.2

Fit folded wear-ring [361E] into the centerblock internal groove and repeat it with second wear-rings [361E].



Fig. 3.7.3

Fit O-ring [47E] into the internal centerblock internal groove.

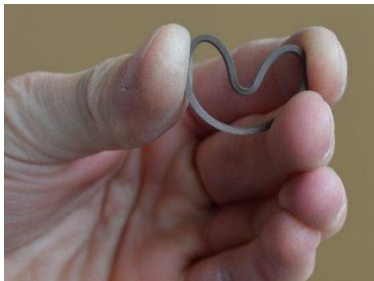

Fig. 3.7.4

Squeeze wear-ring [362E] to ease grabbing it with pliers.



Fig. 3.7.5

Grab back-up wear-ring [362E] with pliers and cover the O-ring [47E].

3. MAINTENANCE

3.7.2. Assembly of the air valve

NOTE! Assembly should be proceed with the protecting gloves in order to prevent air valve from dust and dirt contamination.

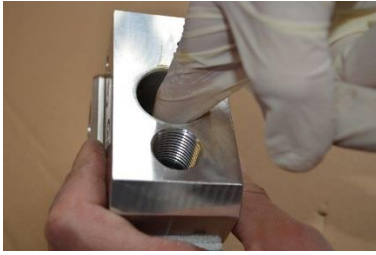

Fig. 3.7.6

Before assembly of the air valve [61E] put few drops of the lubricant on the inside of the air valve hole.

NOTE! Use only strictly defined lubricant - [Optimol Obeen UF2](#)



Fig. 3.7.7

When putting the air valve [61E] into the centerblock [12E], remember to keep appropriate orientation.

NOTE! Although the air valve [61E] consist of a few loose components, it is a one device. Therefore do not change the order when pulling out of the box.

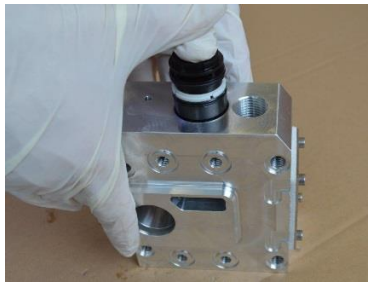

Fig. 3.7.8

Fit the main part of the air valve [61E] into the centerblock hole.

Rotate the end cap to allow retaining it with screws [27E], then Press the assembly of the air valve [61E] to the very end of centerblock hole.



Fig. 3.7.9

Be careful to align the end cap as if incorrectly orientated the retaining screws cannot be inserted.



Fig. 3.7.10

Using allen key, screw both air valve retaining screw [27E] to fix the air valve [61E].

3. MAINTENANCE



Fig. 3.7.11

Fit the O-rings [1212E, 1213E and 1214E] into the centerblock grooves.

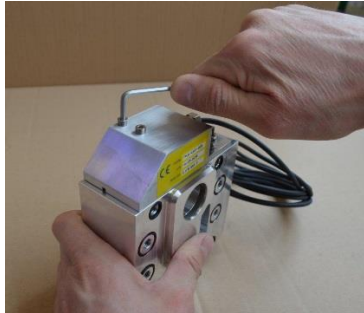

Fig. 3.7.12

Attach the control module [97E] together with control module gasket [971E].

NOTE! Remember to fit gasket in appropriate position according to chapter 1.2.1., „Internal Pilot (IP) / External Pilot (EP)“.



Fig. 3.7.13

Fit the square O-ring [1211E] into diaphragm back plates.



Fig. 3.7.14

Assemble the diaphragm back plates with universal centerblock [12E].



Fig. 3.7.15

Fix the diaphragm back plate with retaining screws [1202E] and [1203E]*.

*Back plate retaining screws [1203E] only in size T400/T420/T424



Fig. 3.7.16

Fit the O-rings [1212E, 1213E and 1214E] into the centerblock grooves.

3. MAINTENANCE

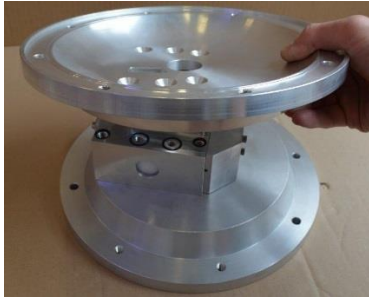

Fig. 3.7.17

Hold the second diaphragm back plate [1201E] a little bit above the universal centerblock [12E].



Fig. 3.7.18

Before inserting the pin screws [14] remember to align axially bushing [1204E] holes with the diaphragm back plates [1201E] and centerblock [12E] holes.



Fig. 3.7.19

Fix the diaphragm back plate with retaining screws [1202E] and [1203E]*.

**Back plate retaining screws [1203E] only in size T400/T420/T424*



Fig. 3.7.20

The remainder of assembly should be performed according to full **PE & PTFE, Metal, Sanitary IOM manual***

3.7.3. Test run



We recommend you to conduct a test run of the pump before installing it in the system, so no liquid gets wasted if the pump leaks or perhaps does not start accordingly to wrong assembly of the pump.

After a few weeks of operation retighten the nuts with appropriate torque [see full IOM manual].

4. SPARE PARTS

4. SPARE PARTS

4.1. TC50, TC70, T80: Intelligent pump Centerblock – Spare parts drawing

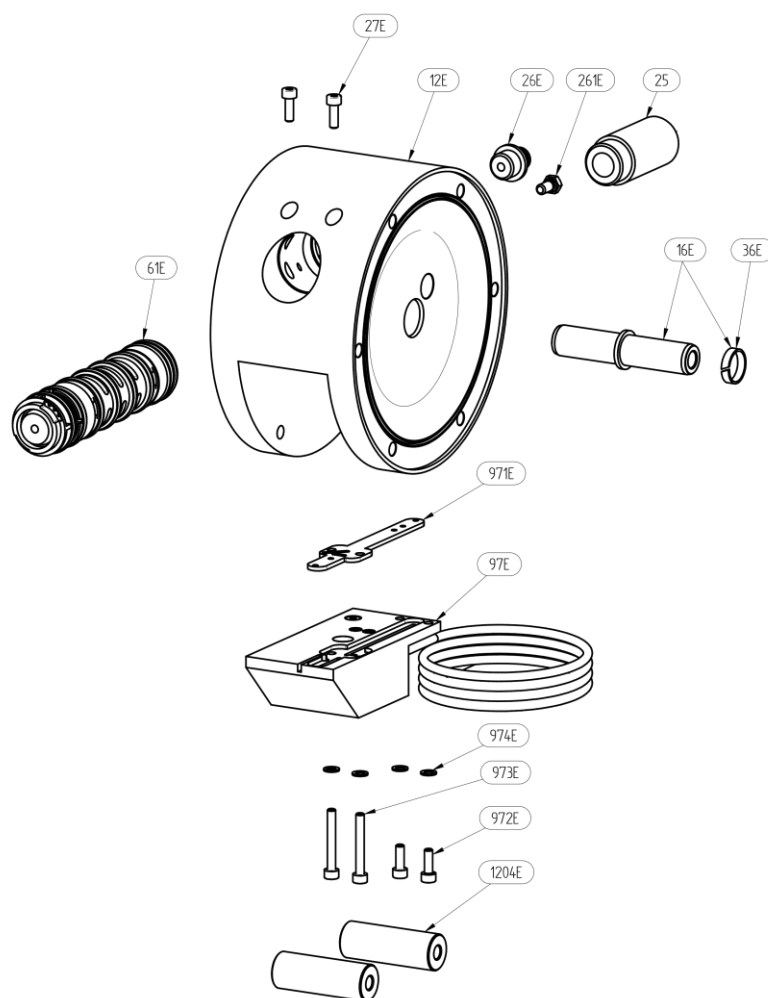

4.2. TC50, TC70, TC80: Intelligent pump Centerblock – Spare parts list

Pos.	Q-ty	Description	Material	KIT AIR
12E	1	Centerblock	Aluminium	
1204E	2	Bushing	Aluminium	
16E	1	Diaphragm shaft	AISI 316L, Zinc plated neodymium	x
25	1	Muffler	PP	x
26E	1	Quick connector pneumatic fitting	Brass	
261E	1	External pilot screw	A4-70	
27E	2	Air valve retaining screw	A4-70	
36E	2	Shaft wear-ring	NBR	x
61E	1	Air valve complete	Body: PTFE coated hard ionized aluminium, Delrin O-rings: NBR	x
97E	1	Control module	Aluminium	

4. SPARE PARTS

971E	1	IP/EP gasket	NBR	x
972E	2	Control module fixing screw	A4-70	
973E	2	Control module fixing screw	A4-70	
974E	4	Washer	A4-70	

4.3. TC100, TC120, TC125: Intelligent pump Centerblock – Spare parts drawing

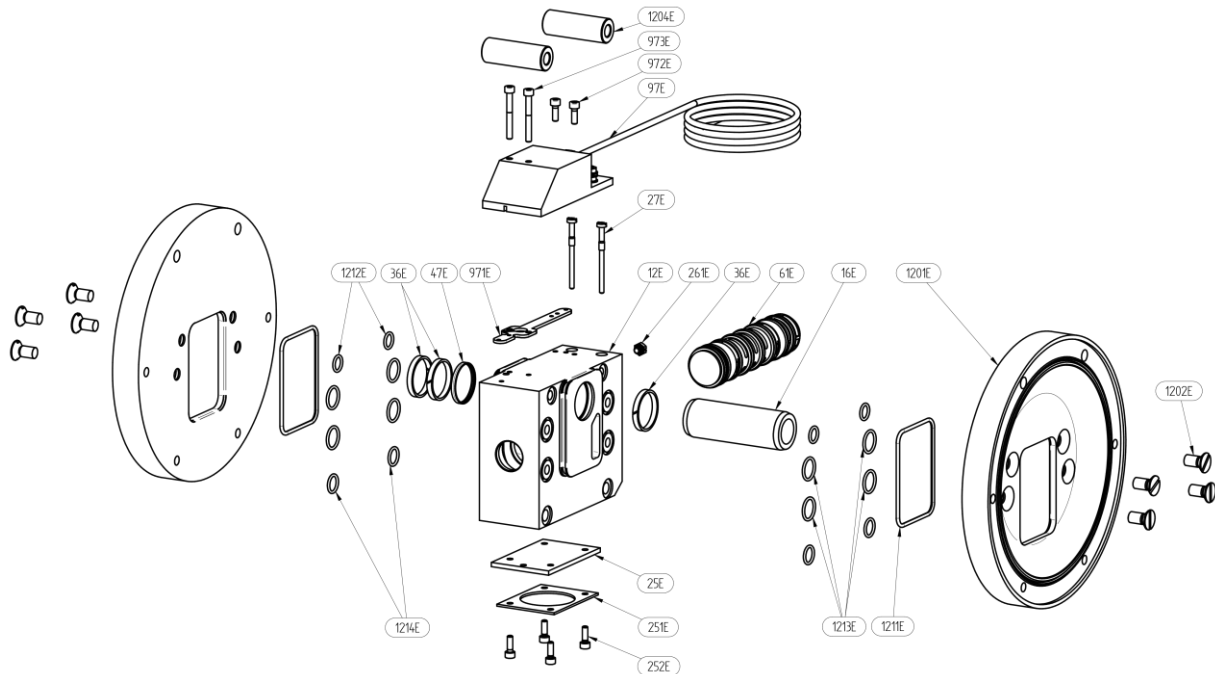

4.4. TC100, TC120, TC125: Intelligent pump Centerblock – Spare parts list

Pos.	Q-ty	Description	Material	KIT AIR
12E	1	Centerblock	Aluminium	
1201E	2	Diaphragm back plate	Aluminium	
1202E	8	Back plate retaining screw	A4-70	
1204E	6	Bushing	Aluminium	
1211E	2	Back plate square O-ring	NBR	x
1212E	4	Back plate O-ring	NBR	x
1213E	8	Back plate O-ring	NBR	x
1214E	4	Back plate O-ring	NBR	x
16E	1	Diaphragm shaft	AISI 316L, Zinc plated neodymium	x
25	1	Muffler	PPM-F	x
251E	1	Muffler retaining plate	Aluminium	
252E	4	Muffler retaining screw	A2-70	
261E	1	External pilot screw	Brass	
27E	2	Air valve retaining screw	A2-70	
361E	2	Shaft cut wear-ring	NBR	x
362E	1	Shaft wear-ring (back-up for 47E)	NBR	x
47E	1	O-ring	?	
61E	1	Air valve complete	Body: PTFE coated hard ionized aluminium, Delrin O-rings: NBR	x
97E	1	Control module	Aluminium	x
971E	1	IP/EP gasket	NBR	
972E	2	Control module retaining screw	A2-70	
973E	2	Control module retaining screw	A2-70	
974E	4	Washer	A2-70	

4. SPARE PARTS

4. SPARE PARTS

4.5. TC200, TC220, TC225: Intelligent pump Centerblock – Spare parts drawing

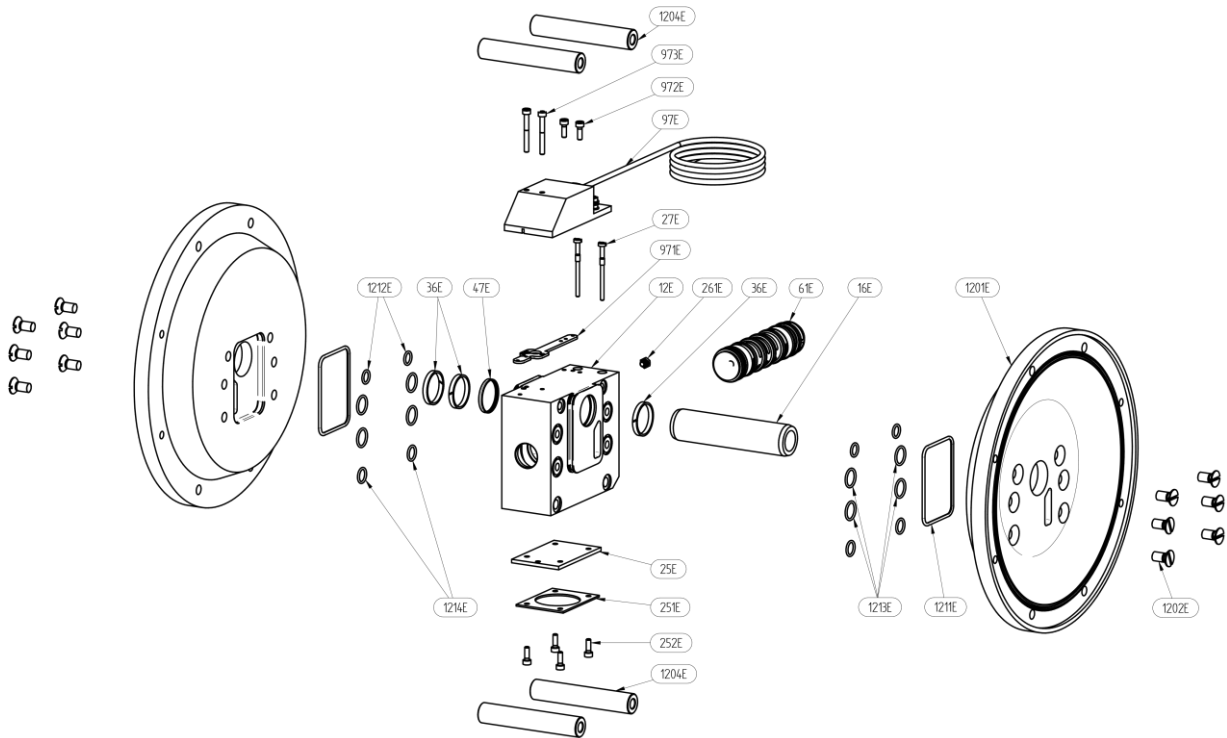

4.6. TC200, TC220, TC225: Intelligent pump Centerblock – Spare parts list

Pos.	Q-ty	Description	Material	KIT AIR
12E	1	Centerblock	Aluminium	
1201E	2	Diaphragm back plate	Aluminium	
1202E	8	Back plate retaining screw	A4-70	
1204E	6	Bushing	Aluminium	
1211E	2	Back plate square O-ring	NBR	x
1212E	4	Back plate O-ring	NBR	x
1213E	8	Back plate O-ring	NBR	x
1214E	4	Back plate O-ring	NBR	x
16E	1	Diaphragm shaft	AISI 316L, Zinc plated neodymium	x
25	1	Muffler	PPM-F	x
251E	1	Muffler retaining plate	Aluminium	
252E	4	Muffler retaining screw	A2-70	
261E	1	External pilot screw	Brass	
27E	2	Air valve retaining screw	A2-70	
361E	2	Shaft cut wear-ring	NBR	x
362E	1	Shaft wear-ring (back-up for 47E)	NBR	x
47E	1	O-ring	?	
61E	1	Air valve complete	Body: PTFE coated hard ionized aluminium, Delrin O-rings: NBR	x
97E	1	Control module	Aluminium	x
971E	1	IP/EP gasket	NBR	
972E	2	Control module retaining screw	A2-70	
973E	2	Control module retaining screw	A2-70	
974E	4	Washer	A2-70	

4. SPARE PARTS

4.7. TC400, TC420, TC425: Intelligent pump Centerblock – Spare parts drawing

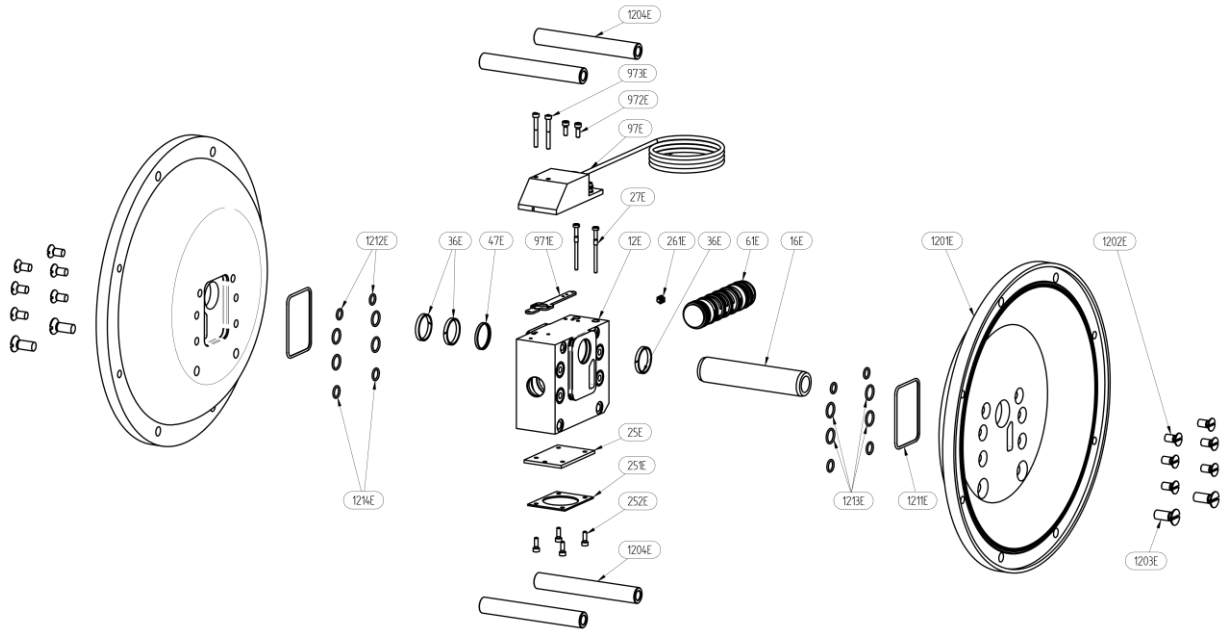

4.8. TC400, TC420, TC425: Intelligent pump Centerblock – Spare parts list

Pos.	Q-ty	Description	Material	KIT AIR
12E	1	Centerblock	Aluminium	
1201E	2	Diaphragm back plate	Aluminium	
1202E	12	Back plate retaining screw	A4-70	
1203E	4	Back plate retaining screw	A4-70	
1204E	6	Bushing	Aluminium	
1211E	2	Back plate square O-ring	NBR	x
1212E	4	Back plate O-ring	NBR	x
1213E	8	Back plate O-ring	NBR	x
1214E	4	Back plate O-ring	NBR	x
16E	1	Diaphragm shaft	AISI 316L, Zinc plated neodymium	x
25	1	Muffler	PPM-F	x
251E	1	Muffler retaining plate	Aluminium	
252E	4	Muffler retaining screw	A2-70	
261E	1	External pilot screw	Brass	
27E	2	Air valve retaining screw	A2-70	
361E	2	Shaft cut wear-ring	NBR	x
362E	1	Shaft wear-ring (back-up for 47E)	NBR	x
47E	1	O-ring	?	
61E	1	Air valve complete	Body: PTFE coated hard ionized aluminium, Delrin O-rings: NBR	x
97E	1	Control module	Aluminium	x
971E	1	IP/EP gasket	NBR	
972E	2	Control module retaining screw	A2-70	
973E	2	Control module retaining screw	A2-70	
974E	4	Washer	A2-70	

4. SPARE PARTS

4.9. Stocking recommendation

Even at normal operation some details in the pump will be worn. In order to avoid expensive breakdowns we recommend having a few spare parts in stock.

Depending on the severity of the operation and the importance of assuring continuous work we offer three different spare part **KITS**, please check full **PE & PTFE, Metal, Sanitary IOM manual*** for further instructions. Please keep in mind that IAODD pump **KIT AIR** differs from standard PE & PTFE, Metal or Sanitary pump*.

NOTE! However control module [97E] is not a subject to wear, remember to replace it in case of leakage through muffler.

**depends on the product series*

T50, T70, T80

	Pos.	Description	Q-ty
KIT AIR	16E	Complete diaphragm shaft	1
	18	O-ring set in/outlet	4
	25	Muffler	1
	61E	Complete Air valve	1
	971E	IP/EP gasket	1

T100, T120, T125, T200, T220, T225, T400, T420, T425

	Pos.	Description	Q-ty
KIT AIR	18	O-ring set in/outlet	4
	16E	Complete diaphragm shaft	1
	1211E	Back plate square O-ring	2
	1212E	Back plate O-ring	4
	1213E	Back plate O-ring	8
	1214E	Back plate O-ring	4
	361E	Shaft cut wear-ring	2
	362E	Shaft wear-ring (back-up for 36E)	1
	25E	Muffler	1
	61E	Complete Air valve	1
	971E	IP/EP gasket	1

5. WARRANTY

5. WARRANTY

5.1. Warranty form

Company:	_____
Telephone:	_____ Fax: _____
Address:	_____
Country:	_____ Contact Name: _____
E-mail:	_____
Delivery Date:	_____ Date of pump installation: _____
Pump type:	_____
Serial No (see name plate or stamped on pump housing):	_____
Description of the fault:	_____ _____ _____
The installation:	
Liquid:	_____
Temperature [°C]:	_____ Viscosity [cPs]: _____ Spec grav. [kg/m ³]: _____ pH-value: _____
Content of particles:	_____ % of max size [mm]: _____
Flow [l/min]:	_____ Duty [h/day]: _____ No of starts per day: _____
Discharge head [mWC]:	_____ Suction head / lift [m]: _____
Air pressure [bar]:	_____ Quality of the air (filter, micron, lubrication): _____
Other:	_____ _____
Place for sketch of installation:	

5. WARRANTY

5.2. Returning parts

When returning parts to Tapflo please follow this procedure:

- Consult Tapflo for shipping instructions.
- Cleanse or neutralize and rinse the part/pump. Make sure the part/pump is completely empty from liquid.
- Pack the return articles carefully to prevent any damage during transportation.

Goods will not be accepted unless the above procedure has been complied with.

5.3. Warranty

Tapflo warrants products under conditions as stated below for a period of not more than 5 years from installation and not more than 6 years from date of manufacturing.

1. The following terms and conditions apply to the sale of machinery, components and related services and products, of Tapflo (hereinafter "the products").
2. Tapflo (the manufacturer) warrants that:
 - a. its products are free of defects in material, design and workmanship at the time of original purchase;
 - b. its products will function in accordance with Tapflo operative manuals; Tapflo does not guarantee that the product will meet the precise needs of the Customer, except for those purposes set out in any invitation to render documents or other documents specifically made available to Tapflo before entering into this agreement;
 - c. high quality materials are used in the construction of the pumps and that machining and assembly are carried out to the highest standards.

Except as expressly stated above, Tapflo makes no warranties, express or implied, concerning the products, including all warranties of fitness for a particular purpose.

3. This warranty shall not be applicable in circumstances other than defects in material, design, and workmanship. In particular warranty shall not cover the following:
 - a. Periodic checks, maintenance, repair and replacement of parts due to normal wear and tear (seals, O-rings, rubber items, diaphragms, air valves etc.);
 - b. Damage to the product resulting from:
 - b.1. Tampering with, abuse or misuse, including but not limited to failure to use the product for its normal purposes as stated at the time of purchase or in accordance with Tapflo instructions for use and maintenance of the product, or the installation or improper ventilation or use of the product in a manner inconsistent with the technical or safety standard in force;
 - b.2. Repairs performed by non-skilled personnel or use of non-original Tapflo parts;

5. WARRANTY

- b.3. Accidents or any cause beyond the control of Tapflo, including but not limited to lightning, water, fire, earthquake, and public disturbances, etc.;
4. The warrantee shall cover the replacement or repairing of any parts, which is documented faulty due to construction or assembling, with new or repaired parts free of charges delivered by Tapflo. Parts subjected to normal tear and wear shall not be covered by the warranty. Tapflo shall decide as to whether the defective or faulty part shall be replaced or repaired.
 5. The warrantee of the products shall be valid for a period in accordance to the current law from the date of delivery, under the condition that notice of the alleged defect to the products or parts thereof be given to Tapflo in written within the mandatory term of 8 days from the discovery. Repair or replacement under the terms of this warranty shall not give a right to an extension to, or a new commencement of, the period of warranty.
 6. Repair or replacement under the terms of this warranty shall not give a right to an extension to, or a new commencement of, the period of warranty. Repair or replacement under the terms of this warranty may be fulfilled with functionally equivalent reconditioned units. Tapflo qualified personnel shall be solely entitled to carry out repair or replacement of faulty parts after careful examination of the pump. Replaced faulty parts or components will become the property of Tapflo.
 7. The products are built in accordance with standard CE normative and are tested (where applicable) by Tapflo. Approval and tests by other control authority are for the customer's account. The products shall not be considered defective in materials, design or workmanship if they need to be adapted, changed or adjusted to conform to national or local technical or safety standards in force in any country other than that for which the unit was originally designed and manufactured. This warranty shall not reimburse such adaptations, changes or adjustments, or attempt to do so, whether properly performed or not, nor any damage resulting from them, nor any adaptation, change or adjustments to upgrade the products from their normal purpose as described in the products operative manual without the prior written consent of Tapflo.
 8. Installation, including electric and other connections to utility mains according to Tapflo drawings, is for the cost and responsibility of the customer, unless otherwise agreed in writing.
 9. Tapflo will not be liable on any claim, whether in contract, tort, or otherwise, for any indirect, special, incidental, or consequential damages, caused to the customer or to third parties, including loss of profits, arising by any possible infringement of par. 3 above or by the customer or third parties being in the impossibility of using the products.

Steady the above, Tapflo liability to the customer or third parties from any claim, whether in contract, tort, or otherwise, shall be limited to the total amount paid by the customer for the product that caused the damages.

