

tapflo®

TAPFLO SOLUTIONS™

2026 | 1

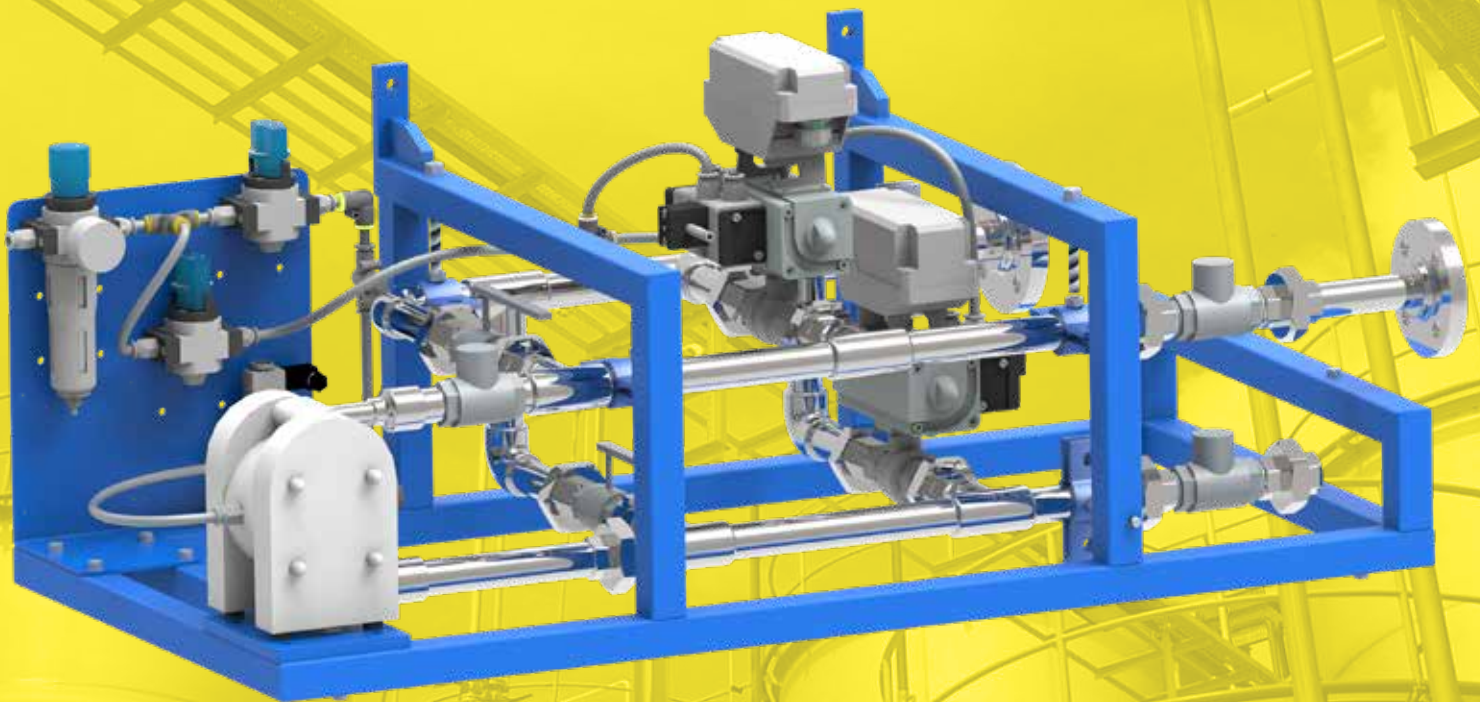

» All about your flow®

www.tapflo.com

» All about your flow®

We began our journey in 1980 in Kungälv, a small town on the Swedish west coast, as a family company with an ambition to one day become a global player on the pump market.

Since the foundation, we have taken pride in delivering a wealth of knowledge and passion for pumps to the industry, whilst supplying a wide range of premium products for various industrial applications.

Over the years, the company has developed into a global Tapflo Group with branches and distributors present in nearly every region of the world.

One thing did not change - we are still a family company.

Our solutions are designed and manufactured in Europe and distributed globally to offer the best service and flow solutions to our customers for a variety of applications.

Our values, Commitment, Quality and Simplicity are reflected both in our product and business approach.



For fast and flexible service and high-quality products readily available worldwide, choose Tapflo.

Quality commitment

At Tapflo we are simply committed to quality. As a result, our production standards, as well as products quality, comply with various globally recognised certification and quality control standards. The Tapflo manufacturing process is certified according to ISO 9001:2015, confirming that our processes are appropriate, effective, customer-focused and continuously improved.



Tapflo values

Our culture is concluded in Our values

Commitment

We are different from our competitors because of our willingness to exceed the customers' expectations, move fast and be flexible. Our culture is based on the spirit of togetherness, enthusiasm and integrity. We come from all over the world but we share the same values and we respect each other. We are committed.

Quality

We understand that the quality in our work is never better than the weakest link, that's why we focus on every small detail. We share a common passion for continuously finding more efficient and effective ways to provide value to our customers. As a manufacturer we have control of the complete process both in terms of our products and the way we operate internally. That is why we manufacture the highest quality pumps in our segment.

Simplicity

We have a saying, "Simple is art" which means we try to find smooth and uncomplicated solutions in everything. By keeping it simple we can focus on the essential, like designing uncomplicated pumps with few components. For us it is a key to success; strive to simplify what is complex.

Customised Flow Systems

Reliability and safety are found as the most desired characteristics of devices applied in industrial processes. To meet customers' need, Tapflo offers tailor-made flow systems of the highest quality.

Our mission is to provide technical solutions that guarantee proper functionality and stable operation in every environment.

Tapflo solutions are successfully applied in the following applications:

Industrial sector:

- Chemical processing industry
- Oil & Gas
- Mechanical industry
- Surface treatment
- Pulp & paper industry
- Paint, print & varnish industry
- Waste water treatment



Hygienic & sanitary sector:

- Food, beverages & drinks
- Dairy, milk & ice cream
- Pharmaceutical industry
- Cosmetics industry
- Processed food



Tapflo Integrated Solutions

Tapflo offers integrated solutions as an possibility to apply standard devices in non-standard applications.

Combining different flow components into one complex unit is an opportunity to suit individual customers' needs, that are related to:

- » Required equipment & functionality
- » Available space
- » Position of connecting flanges
- » Mobility

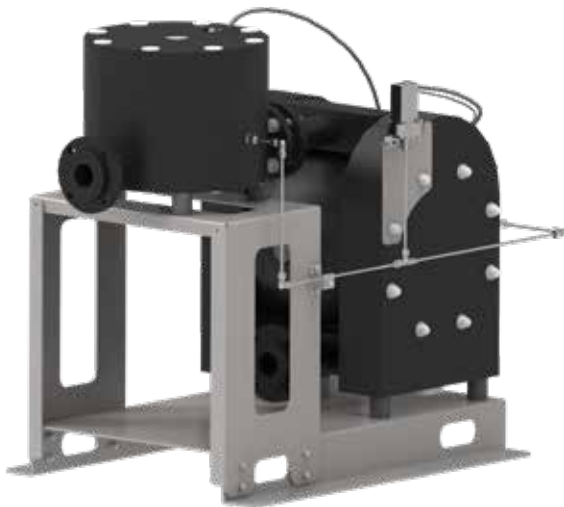

TXB400+DTBX400:
integrated with pneumatic Diaphragm Failure Monitoring System (PDFM).



T225+DT225:
integrated with air pressure booster, built on a hygienic frame.

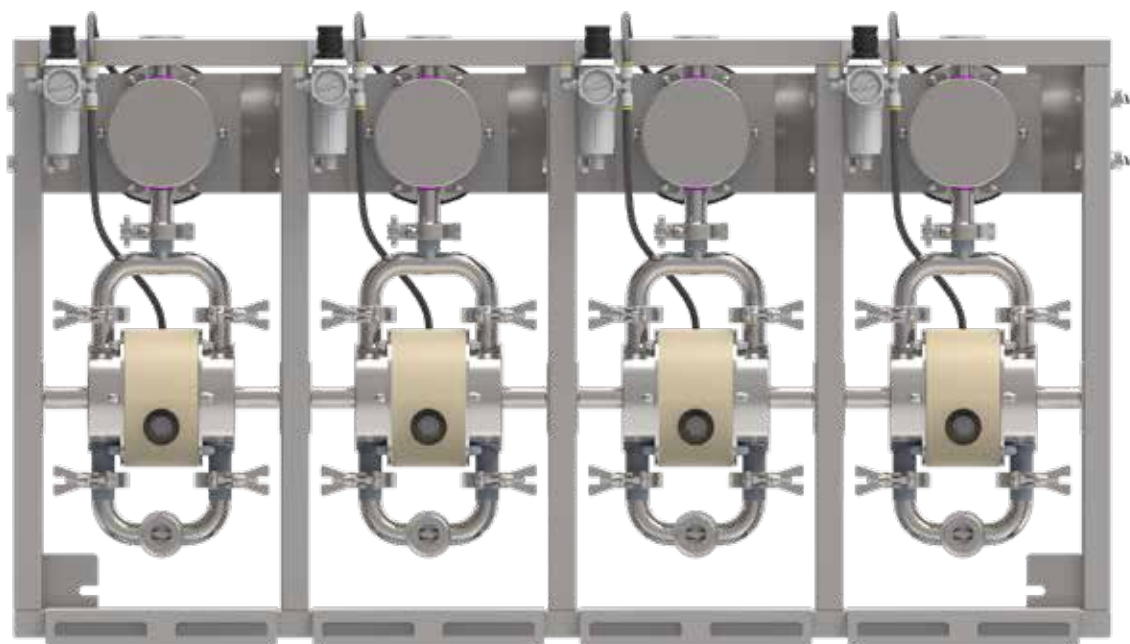

4x T80+DT80:
assembled on a hygienic frame with removable drip pans.

Tapflo Integrated Solutions



Tapflo biggest pumps & dampeners now available as integrated units!



T800+DT800 & T820+DT820: built on one support frame with footprint reduced to less than 0,6 m²!

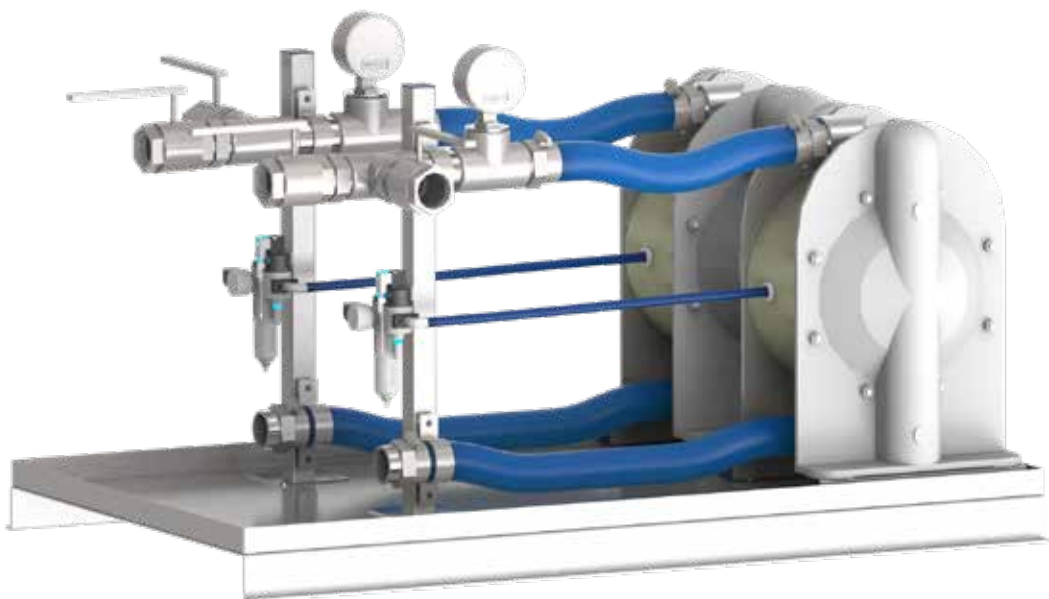

2xT420:

Compact assembly on a support frame with a drip pan.

Ball valves and pressure indicators included to meet customer's needs.

SKID - Customised Process Units

Main elements of Tapflo pumping SKID

Every need for a non-standard pumping system is an opportunity for us to create a unique, made-to-measure SKID.

Tapflo Engineering to Order team has developed a complex unloading solution, that is successfully used to unload barrels containing various chemicals. Tapflo AODD pump is a heart of this process.

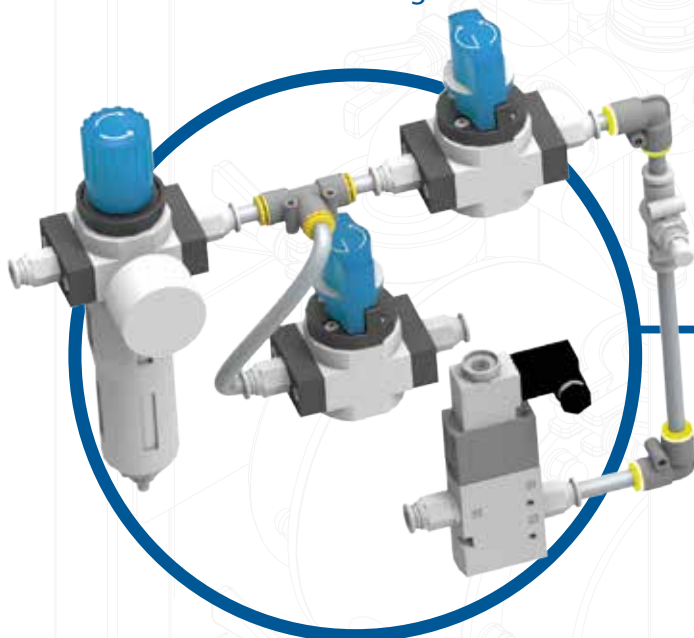

Pneumatic or electric control system:

To optimize the process and have control over it. The pump is stopped after each barrel is emptied. After that the pipelines are flushed with water.



Tapflo pump:

It is the heart of Your process. Tapflo AODD pumps can handle almost every liquid.

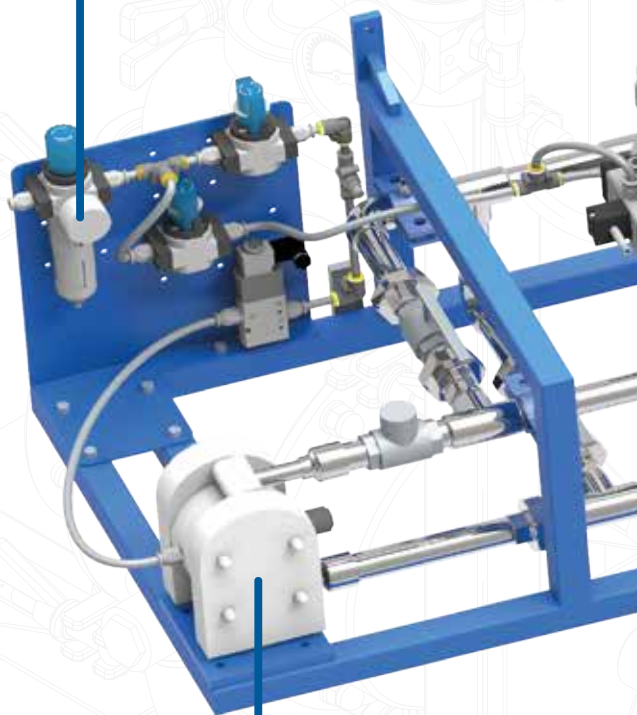

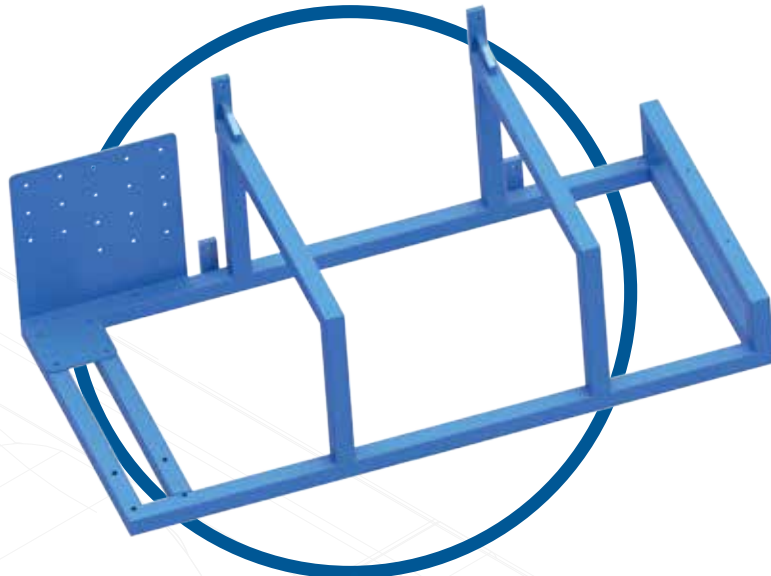

Support frame:

To keep the unit steadily and fit it to available space. Both industrial & hygienic standards are available.

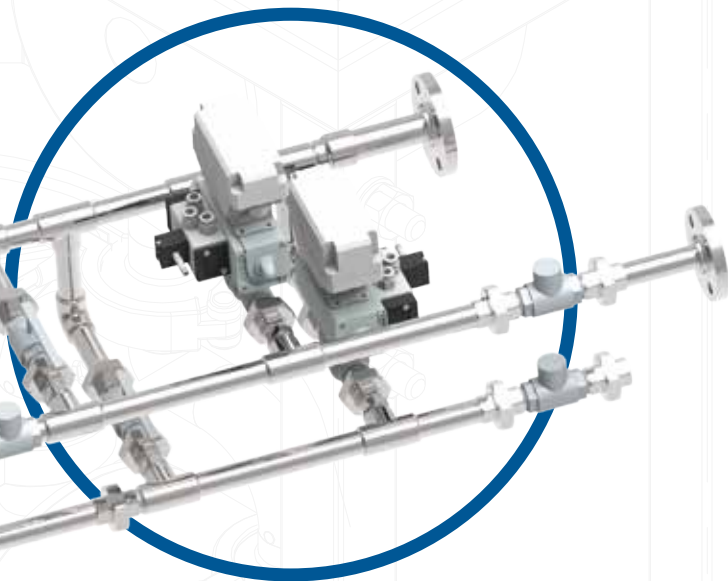
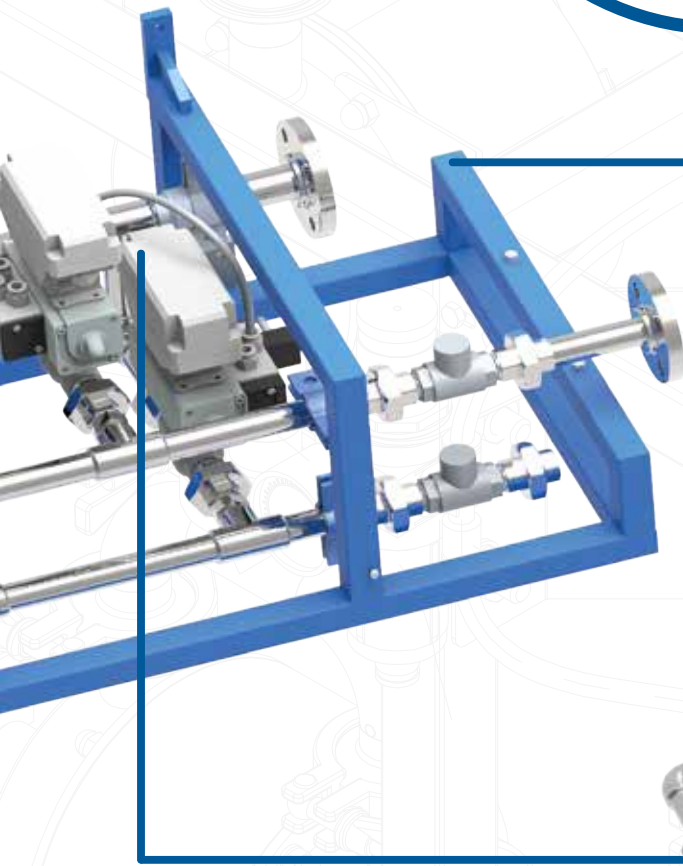

Control valves & pipelines:

As we care about proper flow properties, pipelines in every SKID unit are being analyzed and adjusted to obtain the best possible hydraulic conditions.

SKID - Customised Process Units

Sample solutions

Based on strong experience in design and production, Tapflo offers wide range of compact process pumping systems.

We create units that are dedicated to certain applications in certain industrial sectors. In Tapflo we provide almost limitless possibilities of pump units' development, both in mechanical & automation disciplines.

In addition, Tapflo might take responsibility for project management, assembly works and integration with existing on site systems.



**“WE WORK IN
A TURN-KEY
STANDARD”**

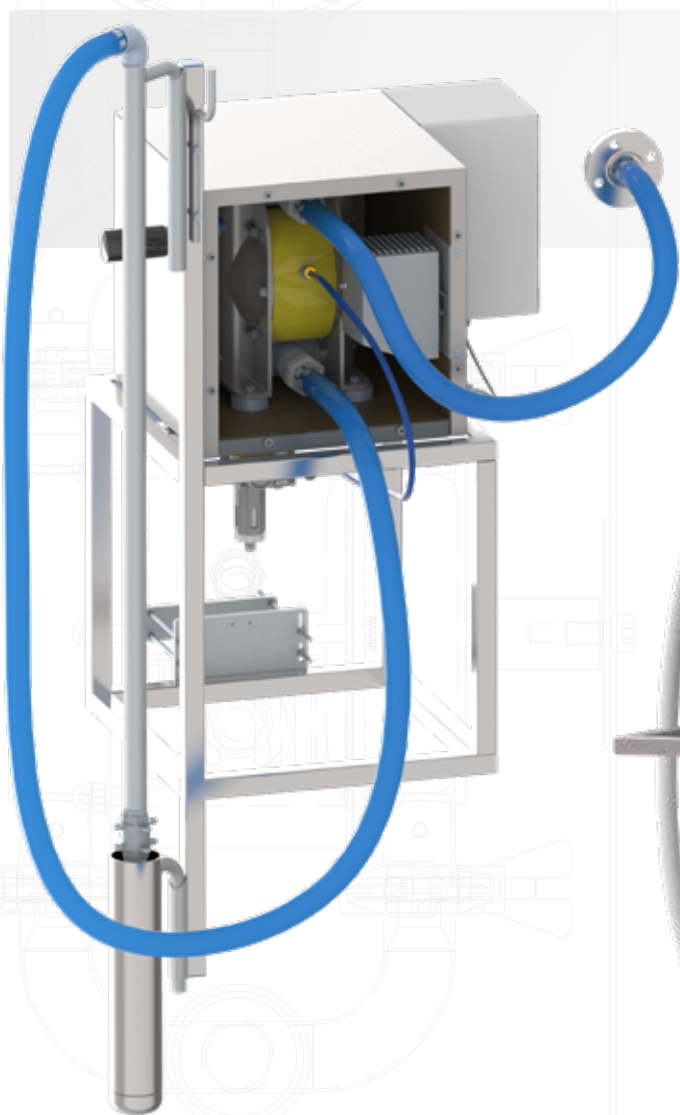

IBC containers unloading unit

Including **Tapflo T120** pump built in a temperature proof box with a control panel. Ready to work in low ambient temperatures.



Mobile mixing & unloading tank

Tapflo CTV 40-13.5 pump to operate in paint industry.

SKID - Customised Process Units

Sample solutions



**"TAPFLO BRINGS
FUNCTIONALITY"**

**Ethanol dispensing
and filtering unit:**

Tapflo TRX20 pump unloading
a container at pharmaceutical
factory. ATEX-approved unit.

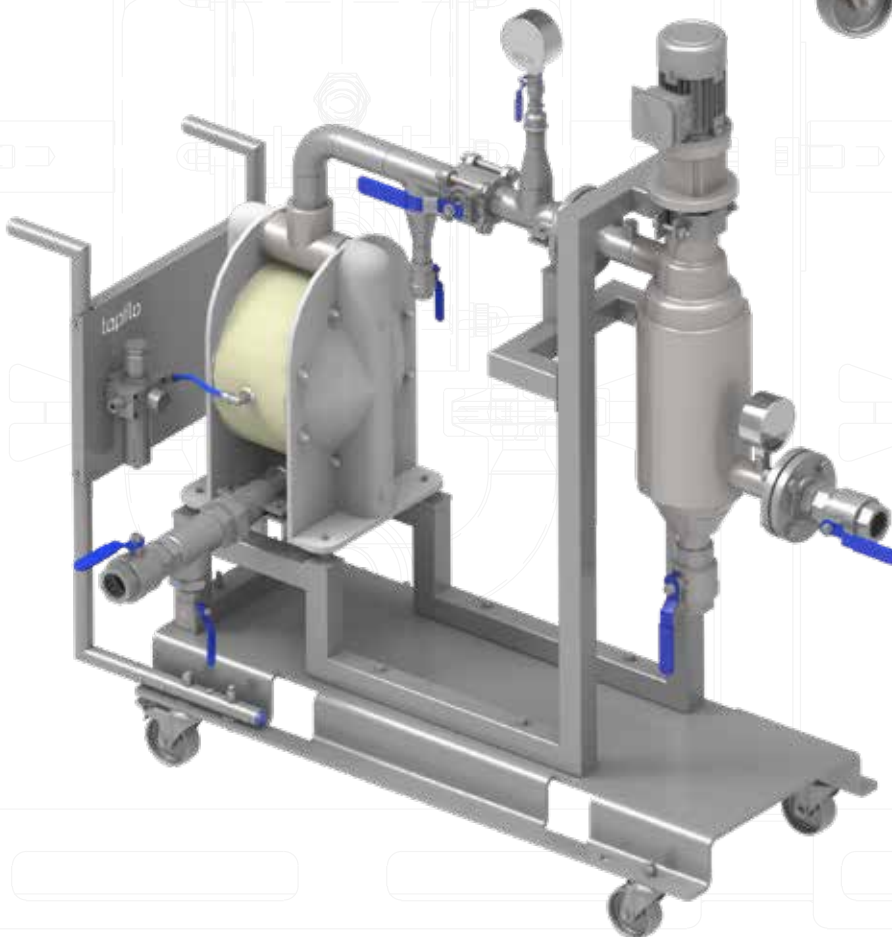

Mobile filtration unit:

Tapflo T420 pump supplying
paint resin through a self-
cleaning filter.

Tapflo Automation & Control Solutions

Tapflo is proud to announce, that we have broadened our offer with automation & control solutions.

By using both pneumatic and electric devices to monitor flow parameters, we are able to ensure safe work of all Tapflo pump units.

» Air Operated Double Diaphragm Pumps



Pneumatic Diaphragm Failure Monitoring System (**PDFM**)



Pneumatic Dry-Run & Dead Head Protection Systems (**PDRN, PDHR, PDHS**)



Electronic Dry Run & Dead Head protection system (**EDHR**)

» Centrifugal Pumps

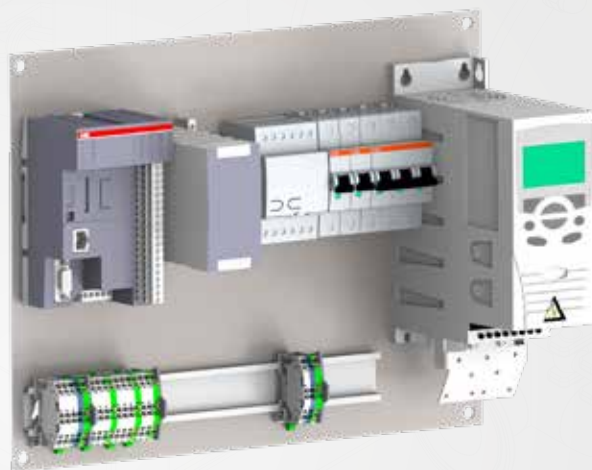











Stainless and painted steel control cabinets available!

- » Built-in frequency inverter
- » Start & stop pushbuttons
- » Main switch: padlockable in OFF position for service purpose
- » Configured according to customer's guidelines

Product range

Diaphragm pumps

 Electrically operated pumps	 PE & PTFE pumps	 Metal pumps	 Pharmaceutical pumps	 Sanitary pumps
 TC Intelligent pumps	 Powder pumps	 TF Filter press pumps	 Steinle filter press pumps	 Aseptic pumps

Centrifugal pumps

 CTXH & I, CTH & I pumps	 CTXS H & I, CTS H & I self-priming pumps	 CTV vertical pumps	 CTP plastic pumps	 CTM magnetic drive pumps
--	---	---	---	---

Other pumps

 Hose pumps	 Submersible pumps	 LPX Lobe pumps*
---	--	--

Mixers

 Industrial Mixers

Systems

 HVS Quattro Drum Unloading System
--

Filters

 FT Filter units
--

Accessories

 Pulsation dampeners	 Control systems	 Hygienic valves	 Hygienic & Industrial Trolleys
--	--	---	---

• offered only in: Australia, Austria, Canada, Denmark, France, Germany, Ireland, Italy, Japan, Netherlands, Portugal, South Africa, Spain, Sweden, United Kingdom

Sweden

Filaregatan 4 | S-442 34 Kungälv

Tel: +46 303 63390

Fax: +46 303 19916

E-mail addresses:

Commercial questions: sales@tapflo.com

Orders: order@tapflo.com

Tech support: support@tapflo.com

Österreich

Töpferweg 1 | 4320 Perg

Tel: +43 732 272 929 10

Fax: +43 732 272 929 00

E-mail: sales@tapflo.at

Tapflo products and services are available worldwide.

Tapflo is represented by own Tapflo Group Companies and carefully selected distributors assuring highest Tapflo service quality for our customers' convenience.

AUSTRALIA | AUSTRIA | AZERBAIJAN | BAHRAIN | BELGIUM | BOSNIA | BRAZIL | BULGARIA | CANADA | CHILE | CHINA | COLOMBIA | CROATIA | CZECH REPUBLIC | DENMARK | ECUADOR | EGYPT | ESTONIA | FINLAND | FRANCE | GEORGIA | GERMANY | GREECE | HONG-KONG | HUNGARY | ICELAND | INDIA | INDONESIA | IRELAND | ISRAEL | ITALY | JAPAN | JORDAN | KAZAKHSTAN | KUWAIT | LATVIA | LIBYA | LITHUANIA | MACEDONIA | MALAYSIA | MEXICO | MONTENEGRO | MOROCCO | NETHERLANDS | NEW ZEALAND | NORWAY | OMAN | PHILIPPINES | POLAND | PORTUGAL | QATAR | ROMANIA | SAUDI ARABIA | SERBIA | SINGAPORE | SLOVAKIA | SLOVENIA | SOUTH AFRICA | SOUTH KOREA | SPAIN | SWEDEN | SWITZERLAND | TAIWAN | THAILAND | TURKEY | UKRAINE | UNITED ARAB EMIRATES | UNITED KINGDOM | USA | UZBEKISTAN | VIETNAM

Tapflo Group Companies

Australia

Tapflo Oceania (Pty) Ltd.
Tel: +61 1800303633
sales@tapflo.com.au

China

Tapflo (Wuxi) Pumps Co. Ltd.
Tel: +86 51082417072
sales@tapflo.cn

Ireland

Tapflo Ireland Ltd.
Tel: +353 12011911
info@tapflo.ie

Poland

Tapflo Sp. z o.o.
Tel: +48 609 995 500
info@tapflo.pl

Spain

Tapflo Ibérica S.L.
Tel: +34 918093182
avives@tapfloiberica.es

Uzbekistan

Tapflo Uzbekistan
Tel: +998 712370940
sales@tapflo.uz

Austria

Tapflo GmbH
Tel: +43 73227292910
sales@tapflo.at

Croatia

Tapflo d.o.o.
Tel: +385 914884666
sales@tapflo.hr

Italy

Tapflo Italia S.r.l.
Tel: +39 0362306528
info@tapfloitalia.com

Qatar

Tapflo Gulf General Trading Co. L.L.C
Tel: +971 58 582 3630
sales@tapfloqulf.com

South Africa

Tapflo (Pty) Ltd.
Tel: +27 317015255
sales@tapflo.co.za

Bahrain

Tapflo Gulf General Trading Co. L.L.C
Tel: +971 58 582 3630
sales@tapfloqulf.com

Czech Republic

Tapflo s.r.o.
Tel: +420 513033920
tapflo@tapflo.cz

Japan

Tapflo Japan K.K.
Tel: +81 362403510
tapflojp@tapflo.co.jp

Romania

S.C. Tapflo Rom. S.r.l.
Tel: +40 213451255
sales@tapflo.ro

Sweden

Tapflo AB
Tel: +46 (0)30314050
info@tapflo.com

Baltic States

Tapflo SIA
Tel: +371 67472205
sales@tapflo.lv

Denmark

Tapflo Danmark ApS
Tel: +45 36454600
info@tapflo.dk

Kazakhstan

Tapflo LLP
Tel: +7 727 327 83 47
sales@tapflo.kz

Saudi Arabia

Tapflo Gulf General Trading Co. L.L.C
Tel: +971 58 582 3630
sales@tapfloqulf.com

Turkey

Tapflo Makina Ltd.
Tel: +90 2164673311
sales@tapflo.com.tr

Belgium

Tapflo Benelux B.V.
Tel: +31 (0) 6 21850664
info@tapflo.nl

France

Sarl Tapflo France
Tel: +33188788240
info@tapflo.fr

Kuwait

Tapflo Gulf General Trading Co. L.L.C
Tel: +971 58 582 3630
sales@tapfloqulf.com

Serbia

Tapflo d.o.o.
Tel: +381 21445808
sales@tapflo.rs

Ukraine

Tapflo LLC
Tel: +380 442226844
sales@tapflo.ua

Bulgaria

Tapflo EOOD
Tel: +359 886 124 937
office@tapflo.bg

Hungary

Tapflo Kft.
Tel: +36 30148 8551
office@tapflo.hu

Netherlands

Tapflo Benelux B.V.
Tel: +31 (0) 6 21850664
info@tapflo.nl

Slovakia

Tapflo s.r.o.
Tel: +421 911137883
tapflo@tapflo.sk

United Arab Emirates

Tapflo Gulf General Trading Co. L.L.C
Tel: +971 58 582 3630
sales@tapfloqulf.com

Canada

Tapflo Canada
Tel: +1 514 409 8380
office@tapflo.ca

India

Tapflo Fluid Handling India Pvt Ltd.
Tel: +91 9028574063
enquiry@tapflo.in

Oman

Tapflo Gulf General Trading Co. L.L.C
Tel: +971 58 582 3630
sales@tapfloqulf.com

Slovenia

Tapflo d.o.o.
Tel: +386 68613474
sales@tapflo.hr

United Kingdom

Tapflo (UK) Ltd.
Tel: +44 2380252325
sales@tapflo pumps.co.uk



If your country is not listed please visit www.tapflo.com/en/contact