

tapflo®

CTP PLASTIC CENTRIFUGAL PUMPS

2025 | 1



» All about your flow®

www.tapflo.ca

CTP Plastic Mechanically Sealed Centrifugal Pumps

unrivalled with strong acids also containing solid particles

The CTP are semi-open impeller single stage centrifugal pumps. Since there are no metal parts on the liquid side, the pumps are ideal for chemical transfer and circulation duties.

CTP pumps are available in polypropylene (CTP PP) and polyvinylidene fluoride execution (CTP PVDF).

CTP PP - polypropylene execution

- » temperature resistance **up to 70 °C**
- » for circulation of pickling baths and degreasing processes
- » provides great mechanical strength

CTP PVDF - polyvinylidene fluoride execution

- » temperature resistance **up to 90 °C**
- » for hot medias
- » great mechanical properties and chemical resistance



Certificates may vary depending on material execution of particular product.

Features

- ✓ Safety drain on air side of the pump
- ✓ Handling liquids with particles possible, even with metallic solids
- ✓ Compact and reliable
- ✓ No metal parts in contact with the liquid
- ✓ Few parts, low maintenance cost, easy to handle

Trimmed impeller

Impeller trimming means **reducing the outer diameter** of the impeller. This leads to the reduction of the circumferential speed inside the centrifugal pump. This operation is done **to fit the required duty point**.

Reduction of the impeller diameter provides an easy and effective way to permanently **reduce both flow and head without changing the rotational speed of the motor**.

Impeller **can be trimmed every 5mm**. For CTP 32 minimum is 90 mm, for CTP 50 - 95 mm.

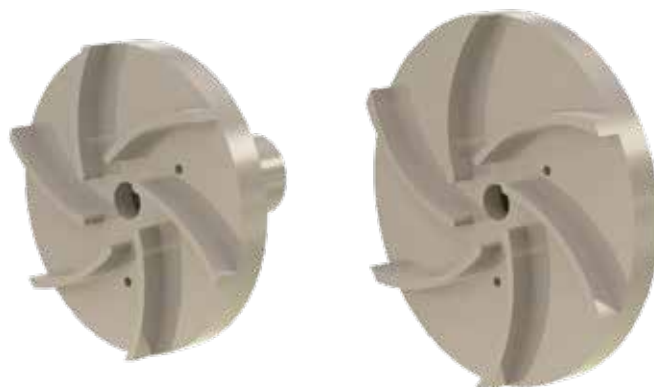

Wide range of applications

CTP

Industries:

- » **chemical,**
- » **surface treatment,**
- » **machinery, echanical,**
- » **foundry,**
- » **paint,**
- » **wastewater treatment plants**

Applications:

acids,
toxic and corrosive chemicals,
detergent concentrates,
circulation of galvanic baths,

feeding and unloading of storage tanks, filters,
containers, sumps.
powering process equipment, dosing systems,
dispensing units, test rigs.



Robust and compact design

Mechanical seal

The **spring is located on the dry side of the pump** therefore all metallic parts are protected against contact with the liquid. This means no elastic bellow is required.



PP & PVDF wetted materials

Can handle highly corrosive liquids also containing solids and metallic particles. Pumps can handle hot alkali and acids.

The version in **PP-GF** (glass fibre reinforced polypropylene) provides great mechanical strength and allows liquid temperatures **up to 70 °C**.

The **PVDF** (polyvinylidene fluoride) version has superior chemical resistance and allows temperatures **up to 90 °C**.

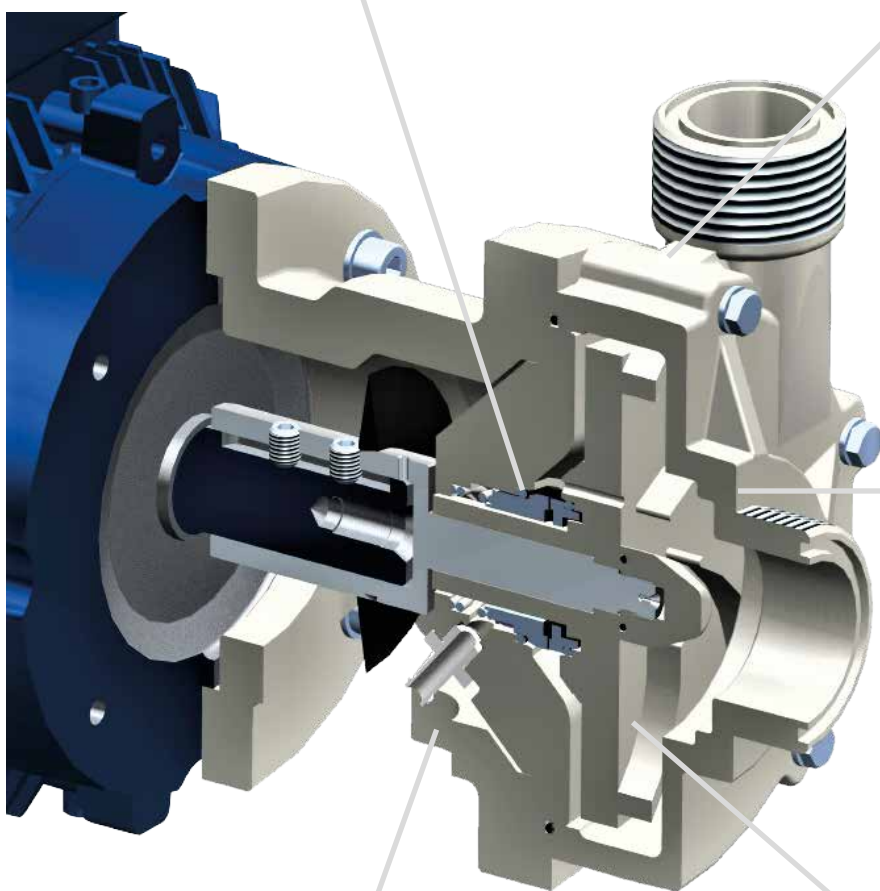

Chemically resistant pumps

The wetted components are non-metallic injection moulded thermoplastics enabling **excellent corrosion resistance**.

The **shaft is protected by means of a plastic sleeve** and nut compatible with the pump housing material.

Safety drain

The special revision hole in the back casing provides a **drainage from the mechanical seal in case any leakage occurs**.

This prevents the motor and shaft from getting into contact with the pumped liquid. The PVDF barb connector allows to plug a hose and reroute the liquid out of the pump.

Semi open impeller

Allows pumping liquids with particles up to **Ø 3 mm and 10% in concentration**.

A semi open impeller also **improves the transfer of liquids with higher viscosity**.



CTP PP & PVDF

Materials, data and limits

Casing	PP-GF (30%) or PVDF
Back casing, Impeller	PP or PVDF
Lantern (not wetted)	PP
Mechanical seal	Rotating part: SiC or Graphite Stationary part: SiC or Ceramic Spring: AISI 316 or Hastelloy C-276 ¹
O-rings	EPDM, FEP/FKM, FKM
Shaft	AISI 316L stainless steel (standard) or Hastelloy [®] C-276
Motor*	IEC standard, 3-phase, 2-pole, IP55
Pressure rating	PP: PN6 at 20 °C; PN2 at 70 °C PVDF: PN6 at 20 °C; PN2 at 90 °C
Temperature	PP: from 0 °C up to 70 °C; PVDF: from -20 °C up to 90 °C
Viscosity	max ~200 cSt
Particles	max diameter is Ø 3 mm and 10% in concentration

¹Hastelloy[®] C is a registered trademark of Haynes International, Inc.

*other motor options available on request

Connection dimensions

Model	BSPT male thread (standard)		DIN 2633/ PN16 flange		Hose	
	Inlet	Outlet	Inlet	Outlet	Inlet	Outlet
CTP 32-12	1 ¼"	1"	DN32	DN25	Ø32	Ø25
CTP 50-12.5	2"	1 ½"	DN50	DN40	Ø50	Ø40

Performance curves

The performance curves are based on water.

$\rho = 1000 \text{ kg/m}^3, T = 20 \text{ }^\circ\text{C}, n = 2900 \text{ rpm (2-pole, 50 Hz)}$

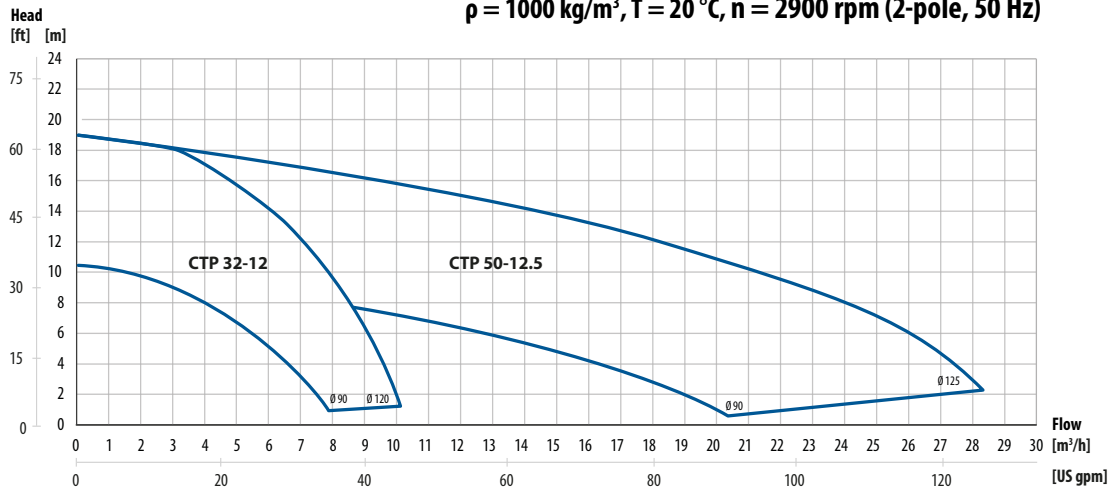

Available motor powers

2-pole motor	32-12		50-12.5	
Motor power [kW]	0.75	1.1	3.0	4.0
IEC motor size	80		100	112

CTP Pump code

I. Tapflo mechanically sealed plastic centrifugal pump II. Pump size III. Impeller size IV. Pump housing material V. Pump options VI. Motor power VII. Motor options

CTP

32

12.5

P

-

1SSV

-

07

P

Mobile Pump Solutions

solve the problem of spread technological processes

The portability of the units allows easy movement to various locations. This means almost limitless application.

Mobile pump units are available in both hygienic and industrial designs. The great advantage is the compatibility with the majority of Tapflo centrifugal pumps range.

Moreover, it is possible to compose the trolley to your own needs by using a number of accessories such as ON-OFF switches, frequency inverters, or cable holders.

Hygienic Trolleys

- » Stainless steel polished drip tray
- » Valve for drainage
- » 3 sizes available



Industrial Trolleys

- » Stainless steel construction
- » Compact and strong baseplate
- » 3 sizes available



Special executions













CTH Liquid Soap Dispensing Unit on M hygienic trolley



CTI mobile transferring pump on the dedicated trolley

Product range

Diaphragm pumps

 Electrically operated pumps	 PE & PTFE pumps	 Metal pumps	 Pharmaceutical pumps	 Sanitary pumps
 TC Intelligent pumps	 Powder pumps	 TF Filter press pumps	 Steinle filter press pumps	 Aseptic pumps

Centrifugal pumps

 CTXH & I, CTH & I pumps	 CTXS H & I, CTS H & I self-priming pumps	 CTV vertical pumps	 CTP plastic pumps	 CTM magnetic drive pumps
--	---	---	---	---

Other pumps

Hose pumps

Submersible pumps

LPX Lobe pumps*

Mixers

Industrial Mixers

Systems

HVS Quattro Drum Unloading System

Filters



FT Filter units

Accessories

Pulsation dampeners

Control systems

Hygienic valves

Hygienic & Industrial Trolleys

• offered only in: Australia, Austria, Canada, Denmark, France, Germany, Ireland, Italy, Japan, Netherlands, Portugal, South Africa, Spain, Sweden, United Kingdom

Canada

101-43 Keefer Crt | Hamilton, ON

Tel: +1 514 409 8380

E-mail address: office@tapflo.ca

We began our journey in 1980 in Kungälv, a small town on the Swedish west coast, as a family company with an ambition to one day become a global player on the pump market.

Since the foundation, we have taken pride in delivering a wealth of knowledge and passion for pumps to the industry, whilst supplying a wide range of premium products for various industrial applications.

Over the years, the company has developed into a global Tapflo Group with branches and distributors present in nearly every region of the world.

One thing did not change - we are still a family company.

Tapflo products and services are available worldwide.

Tapflo is represented by own Tapflo Group Companies and carefully selected distributors assuring highest Tapflo service quality for our customers' convenience.

AUSTRALIA | AUSTRIA | AZERBAIJAN | BAHRAIN | BELGIUM | BOSNIA | BRAZIL | BULGARIA | CANADA | CHILE | CHINA | COLOMBIA | CROATIA | CZECH REPUBLIC | DENMARK | ECUADOR | EGYPT | ESTONIA | FINLAND | FRANCE | GEORGIA | GERMANY | GREECE | HONG-KONG | HUNGARY | ICELAND | INDIA | INDONESIA | IRELAND | ISRAEL | ITALY | JAPAN | JORDAN | KAZAKHSTAN | KUWAIT | LATVIA | LIBYA | LITHUANIA | MACEDONIA | MALAYSIA | MEXICO | MONTENEGRO | MOROCCO | NETHERLANDS | NEW ZEALAND | NORWAY | OMAN | PHILIPPINES | POLAND | PORTUGAL | QATAR | ROMANIA | SAUDI ARABIA | SERBIA | SINGAPORE | SLOVAKIA | SLOVENIA | SOUTH AFRICA | SOUTH KOREA | SPAIN | SWEDEN | SWITZERLAND | TAIWAN | THAILAND | TURKEY | UKRAINE | UNITED ARAB EMIRATES | UNITED KINGDOM | USA | UZBEKISTAN | VIETNAM

Tapflo Group Companies

Australia

Tapflo Oceania (Pty) Ltd.
Tel: +61 1800303633
sales@tapflo.com.au

China

Tapflo (Wuxi) Pumps Co. Ltd.
Tel: +86 51082417072
sales@tapflo.cn

Ireland

Tapflo Ireland Ltd.
Tel: +353 12011911
info@tapflo.ie

Poland

Tapflo Sp. z o.o.
Tel: +48 609 995 500
info@tapflo.pl

Spain

Tapflo Ibérica S.L.
Tel: +34 918093182
avives@tapfloiberica.es

Uzbekistan

Tapflo Uzbekistan
Tel: +998 712370940
sales@tapflo.uz

Austria

Tapflo GmbH
Tel: +43 73227292910
sales@tapflo.at

Croatia

Tapflo d.o.o.
Tel: +385 914884666
sales@tapflo.hr

Italy

Tapflo Italia S.r.l.
Tel: +39 0362306528
info@tapfloitalia.com

Qatar

Tapflo Gulf General Trading Co. L.L.C
Tel: +971 58 582 3630
sales@tapfloqatar.com

South Africa

Tapflo (Pty) Ltd.
Tel: +27 317015255
sales@tapflo.co.za

Bahrain

Tapflo Gulf General Trading Co. L.L.C
Tel: +971 58 582 3630
sales@tapfloqatar.com

Czech Republic

Tapflo s.r.o.
Tel: +420 513033920
tapflo@tapflo.cz

Japan

Tapflo Japan K.K.
Tel: +81 362403510
tapflojp@tapflo.co.jp

Romania

S.C. Tapflo Rom. S.r.l.
Tel: +40 213451255
sales@tapflo.ro

Sweden

Tapflo AB
Tel: +46 (0)30314050
info@tapflo.com

Baltic States

Tapflo SIA
Tel: +371 67472205
sales@tapflo.lv

Denmark

Tapflo Danmark ApS
Tel: +45 36454600
info@tapflo.dk

Kazakhstan

Tapflo LLP
Tel: +7 727 327 83 47
sales@tapflo.kz

Saudi Arabia

Tapflo Gulf General Trading Co. L.L.C
Tel: +971 58 582 3630
sales@tapfloqatar.com

Turkey

Tapflo Makina Ltd.
Tel: +90 2164673311
sales@tapflo.com.tr

Belgium

Tapflo Benelux B.V.
Tel: +31 (0) 6 21850664
info@tapflo.nl

France

Sarl Tapflo France
Tel: +33188788240
info@tapflo.fr

Kuwait

Tapflo Gulf General Trading Co. L.L.C
Tel: +971 58 582 3630
sales@tapfloqatar.com

Serbia

Tapflo d.o.o.
Tel: +381 21445808
sales@tapflo.rs

Ukraine

Tapflo LLC
Tel: +380 442226844
sales@tapflo.ua

Bulgaria

Tapflo EOOD
Tel: +359 886 124 937
office@tapflo.bg

Hungary

Tapflo Kft.
Tel: +36 30148 8551
office@tapflo.hu

Netherlands

Tapflo Benelux B.V.
Tel: +31 (0) 6 21850664
info@tapflo.nl

Slovakia

Tapflo s.r.o.
Tel: +421 911137883
tapflo@tapflo.sk

United Arab Emirates

Tapflo Gulf General Trading Co. L.L.C
Tel: +971 58 582 3630
sales@tapfloqatar.com

Canada

Tapflo Canada
Tel: +1 514 409 8380
office@tapflo.ca

India

Tapflo Fluid Handling India Pvt Ltd.
Tel: +91 9028574063
enquiry@tapflo.in

Oman

Tapflo Gulf General Trading Co. L.L.C
Tel: +971 58 582 3630
sales@tapfloqatar.com

Slovenia

Tapflo d.o.o.
Tel: +386 68613474
sales@tapflo.hr

United Kingdom

Tapflo (UK) Ltd.
Tel: +44 2380252325
sales@tapflo pumps.co.uk



If your country is not listed please visit www.tapflo.com/en/contact