

tapflo®

AIR OPERATED DIAPHRAGM PUMPS

2023 | 1



» All about your flow®

www.tapflo.com

Contents



About Tapflo

Tapflo Diaphragm pumps

Working principle	3
Fast facts	4
Features & Benefits	4
How to install Tapflo pumps	4
Key components of the Tapflo pump	5
Applications	6



PE & PTFE series

General	10
Typical applications	10
The ingenious Tapflo design	10
Special versions	11
Performance curves	12
Dimensions	14
Technical data	15
Pump code	16



Metal series

General	16
Typical applications	17
The ingenious Tapflo design	17
Special versions	17
Performance curves	18
Capacity changes	19
Dimensions	21
Technical data	21
Pump code	22



Sanitary series

General	23
Typical applications	24
The sanitary design	24
Special versions	24
Performance curves	25
Capacity changes	26
Dimensions	27
Technical data	27
Pump code	28

3

4

4

4

4

5

6

8

10

10

10

11

12

14

15

16

16

17

17

17

18

19

21

21

22

23

23

24

24

24

25

26

27

27

28

28

28



Aseptic series

General	29
Typical applications	29
Features & Benefits	29
Performance curves	30
Dimensions	30
Technical data	30



Intelligent pumps - TC series

General	31
Features & Benefits	31



Filter press pumps - TF series

General	32
Features & Benefits	32
The installation	32
Technical data	32



Powder pumps - TP series

General	33
Features & Benefits	33
Working principle	33
Technical data	33



Pharmaceutical pumps - TU series

General	34
Features & Benefits	34



Active pulsation dampeners

General	35
Working principle	35
Options & accessories	35
Dimensions	36
Dampener code	36



Systems & accessories

Guardian systems	37
Control systems	38
Mobile solutions	38
Filter regulator & needle valve kit	39
Pneumixer	39
Contact	40

» All about your flow®

We began our journey in 1980 in Kungälv, a small town on the Swedish west coast, as a family company with an ambition to one day become a global player on the pump market.

Since the foundation, we have taken pride in delivering a wealth of knowledge and passion for pumps to the industry, whilst supplying a wide range of premium products for various industrial applications.

Over the years, the company has developed into a global Tapflo Group with branches and distributors present in nearly every region of the world.

One thing did not change - we are still a family company.

Our solutions are designed and manufactured in Europe and distributed globally to offer the best service and flow solutions to our customers for a variety of applications.

Our values, Commitment, Quality and Simplicity are reflected both in our product and business approach.



For fast and flexible service and high-quality products readily available worldwide, choose Tapflo.

Quality commitment

At Tapflo we are simply committed to quality. As a result, our production standards, as well as products quality, comply with various globally recognised certification and quality control standards. The Tapflo manufacturing process is certified according to ISO 9001:2015, confirming that our processes are appropriate, effective, customer-focused and continuously improved.



Tapflo values

Our culture is concluded in Our values

Commitment

We are different from our competitors because of our willingness to exceed the customers' expectations, move fast and be flexible. Our culture is based on the spirit of togetherness, enthusiasm and integrity. We come from all over the world but we share the same values and we respect each other. We are committed.

Quality

We understand that the quality in our work is never better than the weakest link, that's why we focus on every small detail. We share a common passion for continuously finding more efficient and effective ways to provide value to our customers. As a manufacturer we have control of the complete process both in terms of our products and the way we operate internally. That is why we manufacture the highest quality pumps in our segment.

Simplicity

We have a saying, "Simple is art" which means we try to find smooth and uncomplicated solutions in everything. By keeping it simple we can focus on the essential, like designing uncomplicated pumps with few components. For us it is a key to success; strive to simplify what is complex.

Diaphragm pumps

most versatile pumps on the market

Working principle

Tapflo diaphragm pump is driven by compressed air. Two diaphragms are working simultaneously to prime and push the liquid through the pump system. Valve balls work as check valves to let the liquid through in the right direction.

During each cycle the air pressure on the back of the discharging diaphragm is equal to the head pressure on the liquid side. Tapflo diaphragm pumps can therefore be operated against a closed discharge valve with no adverse effect to the life of the diaphragms.

Suction

One diaphragm creates a suction action when being pulled back from the housing.

DISCHARGE

OPEN

DIAPHRAGM

STROKE

AIR

CLOSED

SUCTION

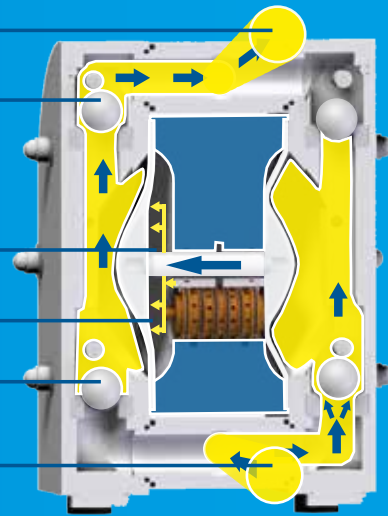

Discharge

The other diaphragm simultaneously transmits the air pressure to the liquid in the housing, pushing it towards the discharge port.

Fast facts

Capacity	0-820 l/min 0 - 216 US gal/min	Pump materials	PE, PTFE, aluminium, cast iron, stainless steel AISI 316L, and PTFE coated aluminium
Pressure	0 - 8 bar (max 16 bar for TF series) 0 - 116 PSI (max 232 PSI for TF series)		
Connection sizes	1/4" up to 4" (DN8 - DN100)		

Features & Benefits

- ✓ **Run dry without damage**
Easy to use, no need of guarding device
- ✓ **Thorough flow control**
Flexible and easy to adjust
- ✓ **Self-priming up to 5 m from dry suction pipe**
More options of installation
- ✓ **No electricity needed**
Explosion proof versions
Ex-zone 1 (ATEX group II, cat 2)
Ex-zone 0 (ATEX group II, cat 1)
- ✓ **Solid, strong construction**
Wide range of working pressures 0-16 bar (depending on pump series)
- ✓ **Few components & long life design**
Low downtime and maintenance cost
- ✓ **Lubrication free air distribution system**
Saves the environment from pollution
- ✓ **Air operated**
Can operate against closed valve. Easy to install without special training (no electricity)

How to install Tapflo pumps

Tapflo Pumps are flexible and easy to install. The in- and outlet ports can rotate 180° to fit your piping system (PE & PTFE and metal series pumps).

Flooded

The piping system is designed with a positive suction head. This is the best way of installation where it is necessary to completely evacuate all liquid from the container, or where viscous (thick) products are transferred.



Self-priming

The Tapflo pump is designed to pull a high vacuum. It is able to evacuate an empty suction pipe without any damage to the pump. The suction lift is up to 5 meters (16.4') from an empty suction pipe and up to 8 meters (26.2') from a wetted pipe. The suction capability depends on the pump size (see pages 16, 23, 28).



Submerged

All Tapflo pumps may be submerged into the liquid. It is important to make sure that all components which are in contact with the liquid are chemically compatible. The air exhaust must be led to the atmosphere by means of a hose.

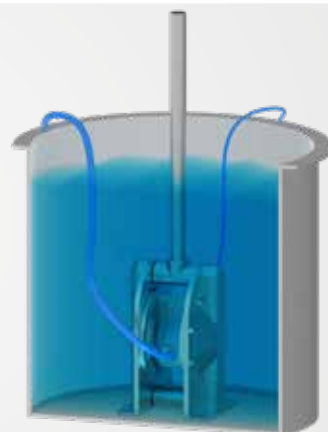

Key components of the Tapflo pump

Long life diaphragms

Tapflo diaphragms are of composite construction, superior for continuous heavy duty service, with a completely smooth surface in contact with the liquid. This results in no leak through and a diaphragm which is easy to keep clean.

The diaphragms are available in various materials and colours to suit any requirements, they are made from **EPDM, NBR, FKM, PTFE, PTFE TFM 1705b, EPDM white, PTFE with white EPDM back, NBR white.**



Multilayer Design

An advanced process of preforming, curing, trimming and finishing results in a long life composite diaphragm that will last for many millions of cycles. All compounds are specially developed and optimized for composite diaphragm technology and compression molding production. Components are chemically bonded by bonding agents and adhesives.

- (1) PTFE TFM layer | (2) Front layer | (3) Core (metal)
- (4) Fabric | (5) Back layer

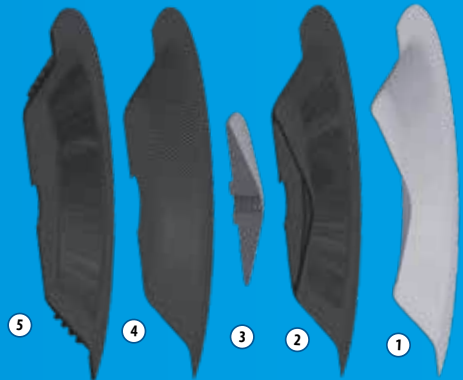

Energy saving drive

The air valve is the driving heart of the pump, redirecting the compressed air to the chambers behind the diaphragms. The air valve is placed in the centre of the pump between the diaphragms, to minimize air ways and dead volumes. This all together is the key to a reliable and energy saving drive.

It is made for maintenance free duty with no lube air, thanks to the ingenious sealing system. **It will not only save your money for lubrication, it will also protect environment from pollution.**

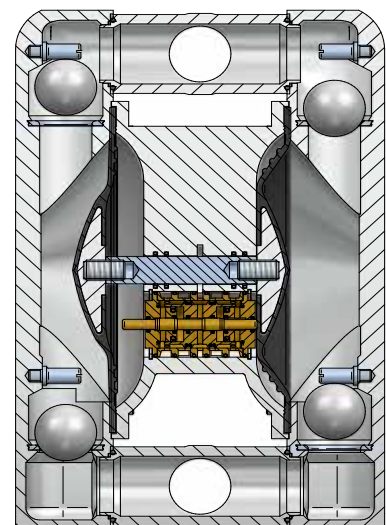

The valve body is made from **brass** or optional **PET** or **stainless steel AISI 316L**.



Ball check valves

The Tapflo pump is fitted with four check valves, making sure that the liquid is transferred in the right direction through the pump.

The ball type valve is the most simple and reliable valve design. It has a good sealing capability and is easy to keep clean and to replace if necessary.

The ball valve materials are available in **EPDM, NBR, PTFE, PTFE TFM 1635, PE1000, FKM, PU, Ceramic, SiC, AISI 316L** to suit any kind of liquid.



Flap valves (Sanitary pumps)

Flap valves are used for pumping liquids containing big solids without damage. Tapflo flap valve pumps are able to pump solids up to **18 mm** in **T80** and **T125**, **42 mm** in **T225** and **T425** and **95 mm** in **T825** pump size. Pumps can reach dry suction lift up to 4,5 meters.

Tapflo Flap Valve design has only two components and are hygienic thus easier to clean.



Magnetic ball lifters (Sanitary & Aseptic pumps)

Possibility to drain the pump is crucial in most hygienic applications. The ball lifting system from Tapflo could not have been easier.

Magnetic ball lifters are implemented in Sanitary and Aseptic series AODD pumps, to enable pump emptying without removing it from the installation when no other draining option is available. Rotating the pump is no longer needed.



Working principle

The valve balls, either made of AISI 420 or PTFE with steel core, are lifted by an influence of magnetic field generated by the ball lifting device. The ball lifting operation is made simply by attaching the magnets to the pumps manifolds.

Valve ball

Magnet lifter

Manifold



Applications

Various liquids - Tapflo pumps are compatible with a very wide range of chemicals:

- » Corrosive and chemical aggressive
- » High and low viscous
- » Abrasive
- » Solid content
- » Shear sensitive
- » Flammable



Chemical industry

Transfer of all kind of acids, alkalis, alcohols, solvents and shear sensitive products such as latex and emulsions, as well as chemical waste products.

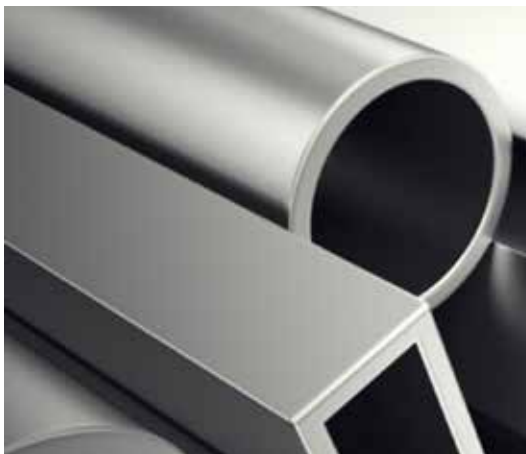
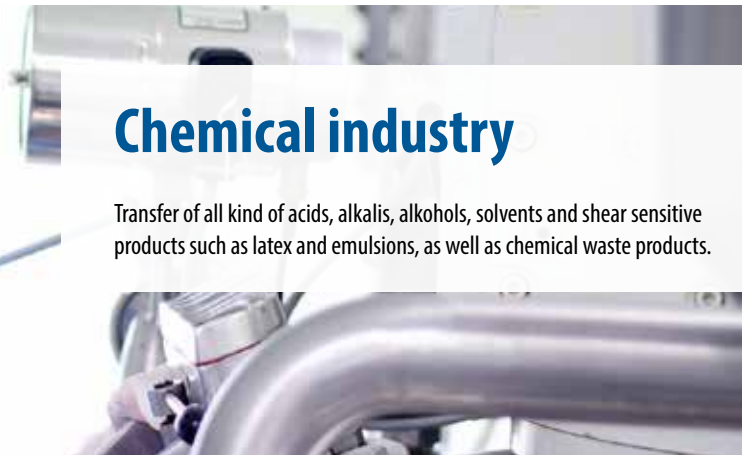

Surface treatment

Transport of chemicals from storage tanks, containers and baths, for example in pickling, galvanization and degreasing. Handling of waste products.



Water treatment

Pumping samples, dosing acids and alkalis for pH-control. Transfer of flocculent, suspensions, chemical reagents and sludges. Pumps are resistant to even most aggressive chemicals.





Pulp and paper industry

Transport of glues, sodium silicate, colours and titanium oxide etc. Bleaching products, sampling and wastewater handling.



Hygienic applications

Transfer of products like: soup, cream, syrup, milk, yoghurt, spirit, chocolate, dough, cream, paste, flavours, aromas, toothpaste etc.



Mechanical industry

Handling of oils, fats, lubricants, cooling liquids, washing and cleaning liquids, solvents, waste products etc.



Paint, print and varnish industry

Transfer of water- and solvent based paints, inks, varnishes, glues adhesives and solvents. Transfer, recirculation and blending of inks in printing industries.

PE & PTFE series pumps

Tapflo pumps made from polyethylene (PE) or polytetrafluoroethylene (PTFE) are suitable for handling almost any kind of liquid whether it is viscous, chemically aggressive or with solids.



Polyethylene pumps

Polyethylene (PE HD) has a superior wear resistance which is 6 – 7 times better than for polypropylene (PP). This fact makes the pump suitable for handling abrasive slurries etc. PE is resistant to most kind of aggressive chemicals such as concentrated acids and alkalis. Maximum liquid temperature is 70°C. Tapflo uses different grades of PE depending on the part. For valve seats and ball stoppers, which are most vulnerable to wear - UHMW PE1000 is used for best mechanical strength and abrasion resistance.

PTFE pumps

PTFE (virgin polytetrafluorethylene) is a thermoplastic polymer with superior chemical resistance. The PTFE pump can handle even the most aggressive acids. Maximum liquid temperature is 110°C.



EN 10204



AT 



The PE & PTFE pump range

- » TR9 - 11 l/min, 1/4"
- » TR20 - 24 l/min, 3/8"
- » T50 - 60 l/min, 1/2"
- » T100 - 125 l/min, 1"
- » T200 - 330 l/min, 1 1/2"
- » T400 - 570 l/min, 2"
- » T800 - 820 l/min, 3"

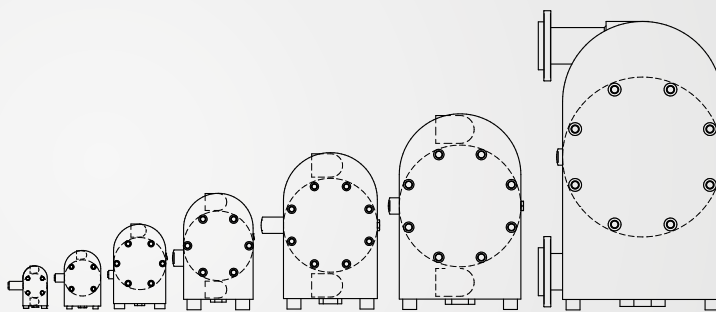

Typical applications

Industry

- » Chemistry
- » Food
- » Pulp & Paper
- » Surface treatment
- » Water treatment
- » Electronics
- » Print & paint

Example of applications

- Acids, alkalis, alcohols, solvents, emulsions
- CIP liquids, flavours, pigments
- Glue, slurries, adhesives, dispersions, resins, sodium silicate, titanium oxide
- Acids, solvents, anodic sludge, varnish, enamels
- Sludge handling, filter press applications, neutralization and flocculants
- Carrier fluids, ultra-pure liquids, electroplating solutions, mercury, solvents
- Glue, additives, varnish, ink, paint, latex, acid, resins, pigments

The ingenious Tapflo design

Few components and a simple design are common for all Tapflo pumps. The pumps are compact, easy and quick to maintain, keeping your service costs and process down time to a minimum.

Flexible installations

The connections may be rotated 180°. Simply turn the connections to fit your piping system. BSP and NPT threaded connections as standard, AISI 316L optional material or other connection types are available as an option. AISI 316 or other connections types are also available.

Solid and strong

The pump body is machined from solid PE or PTFE. The robust design will stand against mechanical forces as well as aggressive chemicals.



Low air consumption

The air distribution system is designed to ensure the shortest possible airflow path and eliminate dead volumes. This results in high efficiency and low air consumption.

Chemical design

The compound diaphragm has a completely smooth liquid side surface and with no metal in contact with the pumped liquid. Ideal for a safe chemical handling.



PE pumps - suitable for most chemicals and abrasive liquids



PTFE pumps - suitable for the most aggressive chemicals

Special versions



Drum pumps | TD series

Light and mobile solution for emptying drums and containers Tapflo TD pumps are irreplaceable in such applications.

The pumps are fitted with a drum tube in polypropylene (PP) or PTFE and a handle in AISI 316L stainless steel.

The PE & PTFE drum pumps range

- » TRD20 - 24 l/min, 1/2" suction, 3/8" discharge
- » TD50 - 60 l/min, 3/4" suction, 1/2" discharge
- » TD100 - 125 l/min, 1 1/4" suction and 1" discharge

Features & Benefits

- ✓ **Customizable tube length**
The drum tube is delivered in any length up to 2 m
- ✓ **Highly mobile and versatile**
Pumps can be easily moved between different drums and containers
- ✓ **Handy and convenient**
Compact pump equipped with comfortable handle



Integrated heavy duty flanges | 3D/3A

The robust design of integrated flanges proves itself useful when there is a risk of vibration from the installation. The solid manifolds provide better stability and sealing for the pump.

This design is a perfect solution for most demanding applications such as in TF Filter press pumps where pump operates at higher pressures.

- » **Available for sizes:** TR20, T50, T100, T200, T400
- » **Available materials:** PE, PE cond., PTFE, PTFE cond.
- » **Flange standard 3A** = ANSI flanges **3D** = DIN flanges

Special versions



Pump with built-on dampener | TK series

The built-on dampener is an ideal solution to eliminate pressure variations on the pumps discharge where space in the installation is limited.

» Available for sizes: TRK20, TK50, TK100, TK200



Twin pumps | TT series

Tapflo PE & PTFE series pumps may be fitted with double in/outlet to achieve "two pumps in one" for blending, mixing or recirculation of liquids.

The liquid in one pump chamber is separated from the other one.

Examples of applications

- » Mixing of two liquids with one pump (50/50 ratio) (installation example)
- » Transfer and return of printing ink from storage to ink tray
- » Transfer and agitation of liquids with one pump

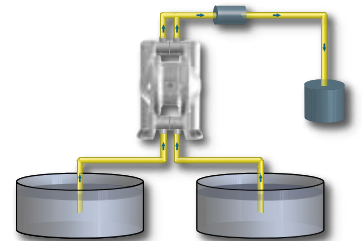

Explosion proof pumps | TX series

The ATEX directive 2014/34/EU (also known as ATEX 114) is applicable on products used in explosion hazardous zones.

Tapflo pumps made from conductive (carbon filled) plastics PE or PTFE are made for use in explosion hazardous environments. They can be used in Ex-zone 1 and Ex-zone 0. The conductive material ensures that no electrostatic loads will be accumulated in the pump.

The conductive pigment in the material reduces the surface resistance. Transfer of alcohol and solvents are examples of applications for the Tapflo TX and TZ pumps.

Tapflo TX ATEX classification:
Ex II 2G Ex h IIC T6... T4 Gb
Ex II 2D Ex h IIIC T60°C... T125°C Db

Tapflo TZ ATEX classification:
Ex II 1G Ex h IIC T6... T4 Ga



Performance curves

The performance curves are based on water at 20°C. Other circumstances might change the performance.

Example see the red line — — — — —

A flow of 6 litre/minute is desired. The discharge head is calculated to 30 mWC. We choose a TR9. It requires an air pressure of 6 bar and will consume approximately 0.10 Nm³/minute.

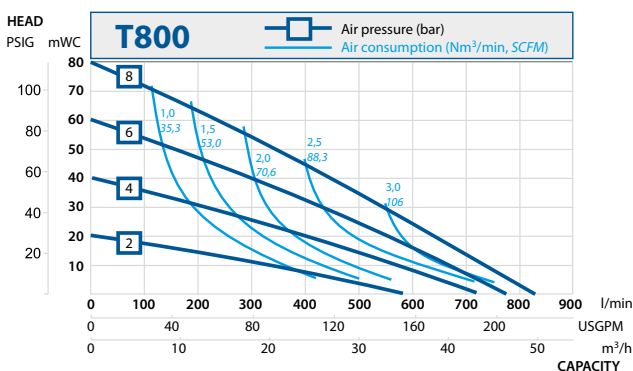
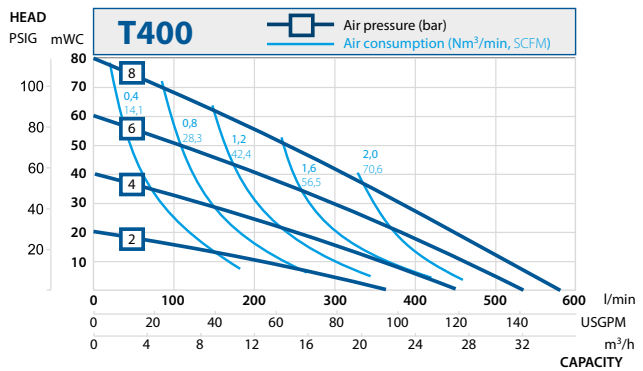
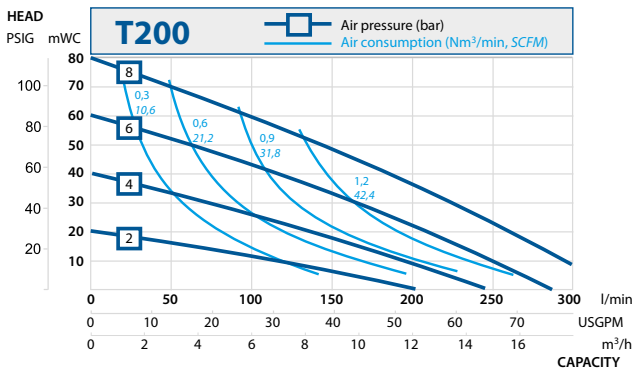
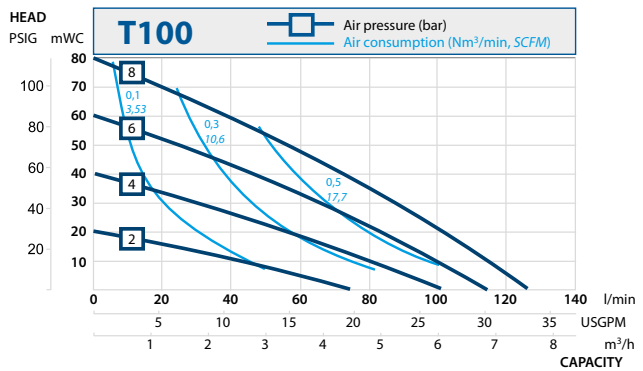
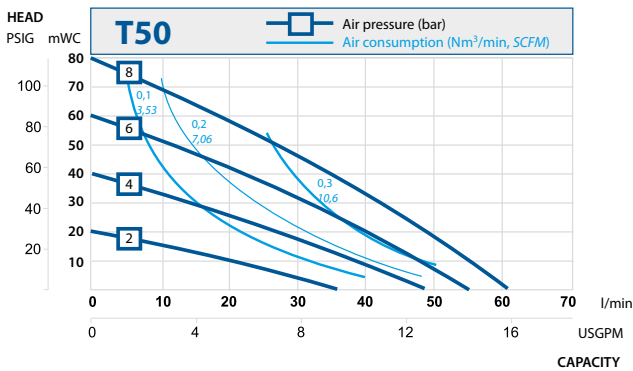
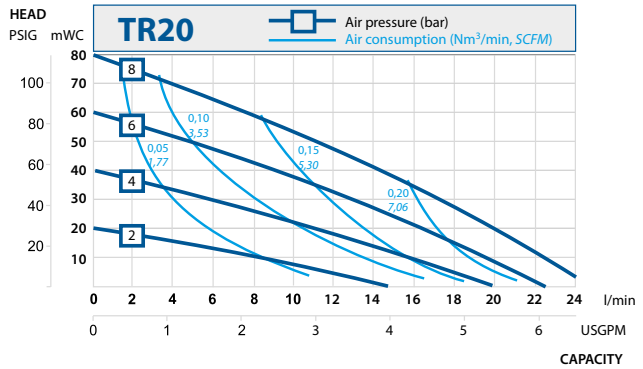
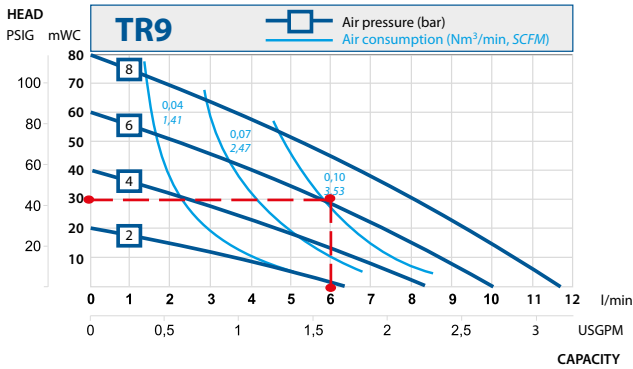

Capacity changes

For changes of capacity due to suction lift or viscosity, please see page 21

Changes reserved without notice

Dimensions

Standard PE pumps

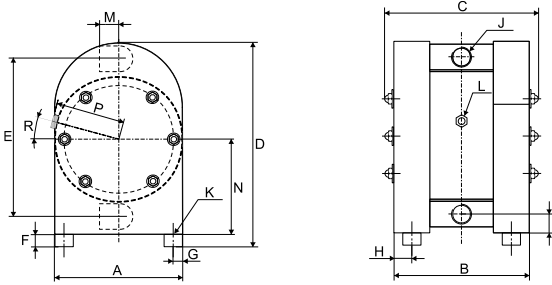

Standard PTFE pumps

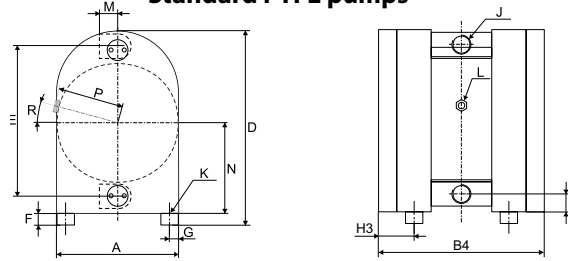

Drum pumps TD

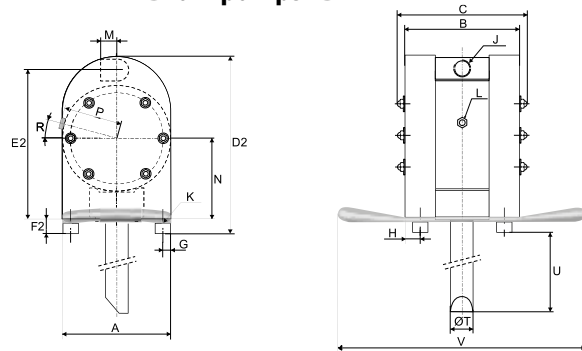

Twin pumps TT

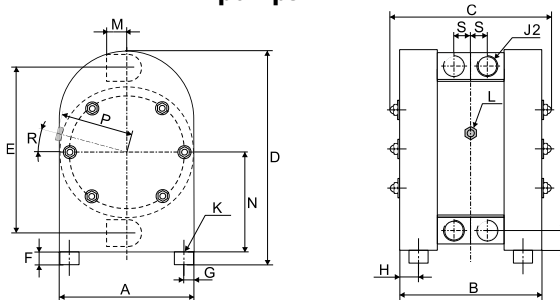

Filter press pumps TF

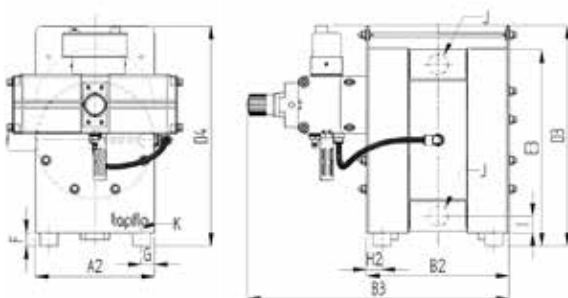

Dimensions for PE & PTFE series

Dimensions in mm (where other is not indicated)

Dimensions in inch (where other is not indicated)

Dim	Pump size						
	9	20	50	100	200	400	800
A	70 2.76	105 4.13	150 5.91	200 7.87	270 10.63	350 13.78	460 18.11
A2	-	-	150 5.91	300 11.81	300 11.81	404 15.91	-
B	94 3.70	113 4.45	162 6.38	216 8.50	313 12.32	382 15.04	557 21.93
B2	-	-	168 6.61	224 8.82	324 12.76	392 15.43	-
B3	-	-	262 10.31	415 16.34	595 23.43	670 26.38	-
B4	134 5.28	152 5.98	202 7.95	256 10.08	352 13.86	422 16.61	-
C	116 4.57	134 5.28	185 7.28	252 9.92	350 13.78	426 16.77	601 23.66
D	123 4.84	168 6.61	243 9.57	320 12.60	450 17.72	563 22.17	830 32.68
D2	-	173 6.81	249 9.80	325 12.80	-	-	-
D3	-	-	352 13.86	351 13.82	501 19.72	583 22.95	-
D4	-	-	343 13.50	364 14.33	500 19.69	610 24.02	-
E	92 3.62	132 5.20	190 7.48	252 9.92	345 13.58	440 17.32	650 25.59
E2	-	147 5.79	210 8.27	280 11.02	-	-	-
E3	-	-	244 9.61	319 12.56	447 17.60	588 21.97	-
F	8 0.31	8 0.31	15 0.59	15 0.59	30 1.18	30 1.18	30 1.18
F2	-	13 0.51	20 0.79	20 0.79	-	-	-
G	9 0.35	15 0.59	17 0.67	30 1.18	30 1.18	30 1.18	20 0.79
H	10 0.39	15 0.59	16 0.63	30 1.18	30 1.18	30 1.18	30 1.18
H2	-	-	19 0.75	34 1.34	35 1.38	35 1.38	-
H3	30 1.18	35 1.38	36 1.42	50 1.97	50 1.97	50 1.97	-
I	12 0.47	15 0.59	20 0.79	28 1.10	38 1.50	48 1.89	80 3.15
J	1/4"	3/8"	1/2"	1"	1 1/2"	2"	3"
J2	1/4"	3/8"	1/2"	3/4"	1"	1 1/2"	-
K	M4x16 M4	M4x16 M4	M8x25 M8	M8x25 M8	M8x25 M8	M8x25 M8	M8x25 M8
L	1/8"	1/8"	1/4"	1/4"	1/2"	1/2"	1/2"
M	15 0.59	17 0.67	25 0.98	38 1.50	54 2.13	70 2.76	105 4.13
N	58 2.28	81 3.19	115 4.53	154 6.06	211 8.31	268 10.55	411 16.18
P	35 1.38	52 2.05	80 3.15	105 4.13	143 5.63	183 7.20	237 9.33
R	0°	0°	15°	15°	0°	0°	0°
S	0°	0°	15°	15°	0°	0°	0°
S	13 0.51	15 0.59	21 0.83	27 1.06	35 1.38	42 1.65	-
ØT	-	20 0.79	32 1.26	32 1.26	-	-	-
U	-	1170*	1170*	1170*	-	-	-
V	-	286 11.26	360 14.17	401 15.79	-	-	-

* = Any length up to 2000 mm upon request

* = Any length up to 79" upon request

General dimensions only, ask us for detailed drawings.
Changes reserved without notice

Technical data

Data	Pump size						
	9	20	50	100	200	400	800
General characteristics							
*Max capacity (l/min) / (US gpm)	11 / 2.9	24 / 6.3	60 / 15.8	125 / 33	330 / 87	570 / 150	820 / 216
**Volume per stroke (ml) / (cu in)	15 / 0.9	26 / 1.6	116 / 7.1	305 / 18.6	854 / 52.1	2326 / 141.9	5240 / 319.8
Max discharge pressure (bar) / (psi)	8 / 116	8 / 116	8 / 116	8 / 116	8 / 116	8 / 116	8 / 116
Max air pressure (bar) / (psi)	8 / 116	8 / 116	8 / 116	8 / 116	8 / 116	8 / 116	8 / 116
****Max suction lift dry (m) / (Ft)	1.6 / 5.25	2.4 / 7.87	4 / 13	3.5 / 11	4 / 13	4 / 13	5 / 16
Max suction lift wet (m) / (Ft)	8 / 26	8 / 26	9 / 29.5	9 / 29.5	9 / 29.5	9 / 29.5	9 / 29.5
Max size of solids (ø in mm) / (in)	2 / 0.08	3 / 0.12	4 / 0.16	6 / 0.24	10 / 0.39	15 / 0.59	15 / 0.59
Max temp, pump in PE (°C) / (°F)	70 / 158	70 / 158	70 / 158	70 / 158	70 / 158	70 / 158	70 / 158
Max temp, pump in PTFE (°C) / (°F)	100 / 212	100 / 212	100 / 212	100 / 212	100 / 212	100 / 212	-
Weight							
Standard pump T in PE (kg) / (lb)	0.75 / 1.65	1.6 / 3.53	4.3 / 9.48	10 / 22	25 / 55.12	47 / 103.62	147 / 342
Standard pump T in PTFE (kg) / (lb)	1.35 / 2.98	3.15 / 6.94	9 / 19.84	17 / 38	47 / 103.62	87 / 191.80	-
Drum pump TD in PE (kg) / (lb)	-	2.4 / 5.29	4.7 / 10.36	10.5 / 23.15	-	-	-
Drum pump TD in PTFE (kg) / (lb)	-	3.9 / 8.6	9.4 / 20.72	17.5 / 38.58	-	-	-
Filter press pump TF in PE (kg) / (lb)	-	-	8 / 17.64	21.6 / 47.62	30 / 66.14	70 / 154.32	-
Material of components							
Pump housing and all wetted thermoplastic details	PE, PE conductive, PTFE, PTFE conductive						PE, PE conductive
Centre block (not wetted)	PP, PE conductive, aluminium						
Diaphragms	PTFE, FKM	PTFE, PTFE 1705B, EPDM, NBR, FKM					
Valve balls	-	PTFE, EPDM, NBR, AISI 316L***, PU, Ceramic***, FKM					
Rod valves (TR9 and TR20)	PE, PTFE		-	-	-	-	-
Air valve	Body: brass (std.), stainless steel AISI 316L or PET O-rings: NBR (std.), EPDM or FKM						
O-rings (wetted)	PTFE, EPDM, FKM, FEP/FKM						
Housing pin screws	Stainless steel						
Diaphragm shaft	Stainless steel AISI 316L (TR9, TR20, T800) / 304L (T50 -T400)						
Drum handle (TD pumps)	-	Stainless steel AISI 316L			-	-	-
Reinforcement plates (TF pumps)	-	-	Stainless steel AISI 304				-

* = Recommended flow is half of the max flow, i.e. recommended flow for a T100 is 62 l/min (16.3 US gpm)

** = The value is based on pumps with PTFE diaphragms (other materials - please contact Tapflo). It should be remembered that the volume per stroke may vary depending on the pump's operating parameters.

*** = Not available on T800

**** = This is max value with stainless steel valve balls, other valve ball materials may reduce the suction. Please consult us

Pump code

The model number on the pump tells the pump size and material of the pump components



I. T = Tapflo diaphragm pump

II. Basic options:

B = Backup diaphragm system

D = Drum pump

F = Filter press pump

K = Pump with built-on dampener (TR20-T200)

R = Rod valve pump

T = Twin inlet/outlet pump

V = AISI 316L valve seat / spacer

X = ATEX approved, group II, cat 2 (zone 1)

Y = High suction lift version

Z = ATEX approved, group II, cat 1 (zone 0)

III. Pump size

IV. Material of wetted thermoplastic parts:

P = PE (polyethylene)

T = PTFE

V. Material of diaphragms:

B = PTFE TFM 1705B (solvents)

E = EPDM

N = NBR (nitrile rubber)

T = PTFE

V = FKM

W = White (food grade) EPDM

Z = PTFE with white back (food grade)

VI. Material of valve balls:

E = EPDM

N = NBR (nitrile rubber)

T = PTFE

S = AISI 316 stainless steel

U = PU (polyurethane)

K = Ceramic

V = FKM

B = PTFE TFM 1635

Material of rod valves (TR9 and TR20 only)

T = PTFE

* = Ask us for complete pump code with all available options and executions. Changes reserved without notice

Metal series pumps

The compact, smooth and simple design is common for this series. Materials available are aluminium, cast iron, stainless steel and PTFE coated aluminium.



Aluminium and cast iron pumps

For transfer of pH-neutral fluids, both thin, thick, high solid content or abrasive. The aluminium and cast iron pumps are found in most fields; workshop and paint industries, purifying plants etc., to mention only a few.

AISI 316 stainless steel pumps

Made in lost wax cast method, ensuring great accuracy and finish. The stainless steel pumps combine great mechanical strength with good chemical features. AISI 316 is resistant to aggressive liquids like nitric acid and sodium hydroxide. The centre block, which is not in contact with liquid, is made from corrosive resistant polypropylene (PP) as standard (other materials upon request).



EN 10204



The metal pump range

- » T25* - 26 l/min, 1/2"
- » T70 - 78 l/min, 3/4"
- » T120 - 158 l/min, 1"
- » T220 - 330 l/min, 1 1/2"
- » T420 - 570 l/min, 2"
- » T820 - 820 l/min, 3"

* = aluminium and cast iron only

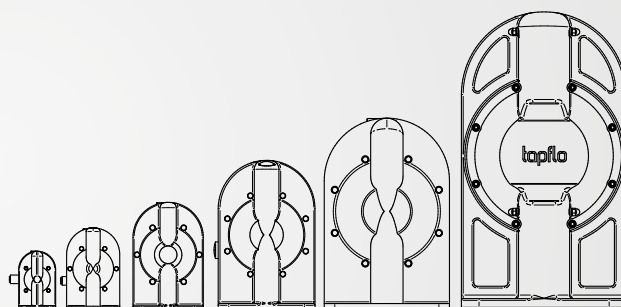

Typical applications

Industry

- » Workshop
- » Print & paint
- » Mining & construction
- » Ceramic industry
- » Chemistry

Example of applications

- Oils, fats, solvents, water, cooling fluids, lubricants
- Glues, additives, varnishes, inks, paints, latex, acids, resins, pigments
- Adhesives, sumps, dewatering, coal sludges, pastes
- Abrasives, glazes, water, enamels, clays
- Acids, alkalis, alcohols, solvents, latex, emulsions

The ingenious Tapflo design

You will discover and appreciate simplicity when you maintain the pump.
We use approximately **70% fewer parts compared with other brands.**



Optional Camlock connections

Metal series diaphragm pumps can be ordered with CAMLOCK connections. The coupling is connected by simply opening the coupler arms and inserting the adaptor into the coupler.

Durable valve seats

The valve seat is under constant stress from the movement of the valve ball. To obtain the best wear resistance, the integrated seat is made from AISI 316 stainless steel.



Flexible installations

The connections may be rotated 180°. Simply turn the connections to fit your piping system. Threaded BSP or NPT connections are standard. Twin connections are also available.

Low air consumption

The air distribution system is designed to ensure the shortest possible airflow path and eliminate dead volumes. This results in high efficiency and low air consumption.



Aluminium and cast iron - suitable for pH neutral liquids



Stainless steel - suitable for chemicals and food applications

Special versions



Drum pumps | TD series

Light and mobile solution for emptying drums and containers Tapflo TD pumps are irreplaceable in such applications.

The pumps are fitted with a drum tube in aluminium or stainless steel and a handle in AISI 316L stainless steel.

The Metal drum pumps range

- » TXD25 - 26 l/min, ½" suction and discharge
- » TXD70 - 78 l/min, ¾" suction and discharge
- » TXD120 - 158 l/min, 1" suction and discharge

Features & Benefits

- ✓ **Customizable tube length**
The drum tube is delivered in any length up to 2 m
- ✓ **Highly mobile and versatile**
Pumps can be easily moved between different drums and containers
- ✓ **Handy and convenient**
Compact pump equipped with comfortable handle



Pneumatic drainage

To ensure process automation Tapflo has developed a pneumatic drainage system. Thanks to this feature, the pump can be drained without detaching from the installation.

» Available for sizes: T120 | T220 | T420

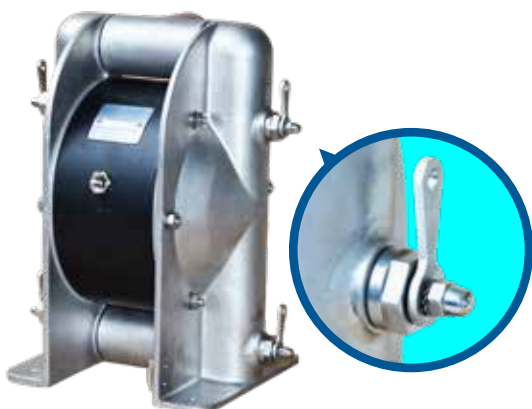

Ball lifters TL

This option is a great way to empty the pump of liquid if there is no possibility of pump disconnection from the installation.

With this easy solution you can simply raise the ball from the valve seat and allow the liquid to flow out of the pump.

» Available for sizes: T70 | T120 | T220 | T420

Special versions



Pump with built-on dampener | TK series

The built-on dampener is an ideal solution to eliminate pressure variations on the pumps discharge where space in the installation is limited.

» Available for sizes: TXK25, TXK70, TXK120, TXK220, TXK420;



Twin pumps | TT series

Tapflo metal series pumps may be equipped with double in/outlet to achieve "two pumps in one" for blending, mixing or circulation of liquids. The liquid in one pump chamber is separated from the other one.

Examples of applications

- » Transfer of two different liquids, two pumps in one
- » Mixing of two liquids with one pump (50/50 ratio)
- » Transfer and return of printing ink from storage to ink tray
- » Transfer and agitation of liquids with one pump (installation example)

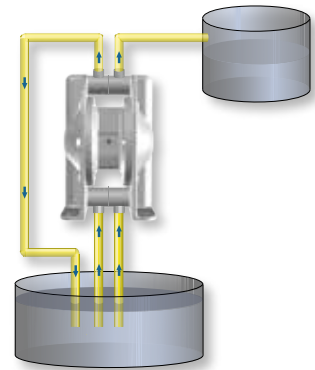

Explosion proof pumps | TX series

The ATEX directive 2014/34/EU (also known as ATEX 114) is applicable on products used in explosion hazardous zones. All aluminum and cast iron pumps are by standard ATEX approved and permitted to be used in Zone 1, having model names TX...

The standard stainless steel pumps are not allowed to operate in hazardous environments. Special conductive TX and TZ pumps are available for such applications. All plastic parts utilized in such pumps are made from conductive (carbon filled) materials thus made for use in explosion hazardous environments. What is more ATEX pump are equipped with a grounding connection.

The aluminium and cast iron pumps can be used in Ex-zone 1. Stainless steel pumps can be utilized in Ex-zone 1 and Ex-zone 0.

The conductive material ensures that no electrostatic loads will be accumulated in the pump.

Tapflo TX ATEX classification:
Ex II 2G Ex h IIC T6... T4 Gb
Ex II 2D Ex h IIIC T60°C... T125°C Db

Tapflo TZ ATEX classification:
Ex II 1G Ex h IIC T6... T4 Ga



Performance curves

The performance curves are based on water at 20°C. Other circumstances might change the performance. See below how the capacity will change at different viscosities and suction lifts. These curves are valid for all metal pumps.

Example see the red line — — — — —

A flow of 10 litre/minute is desired. The discharge head is calculated to 20 mWC. We choose a T25. It requires an air pressure of 4 bar and will consume approximately 0.10 Nm³/min.

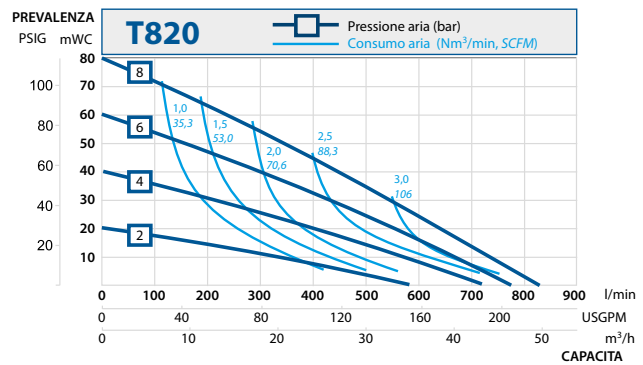
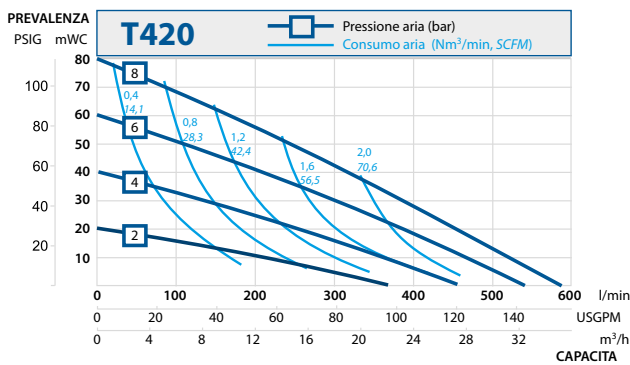
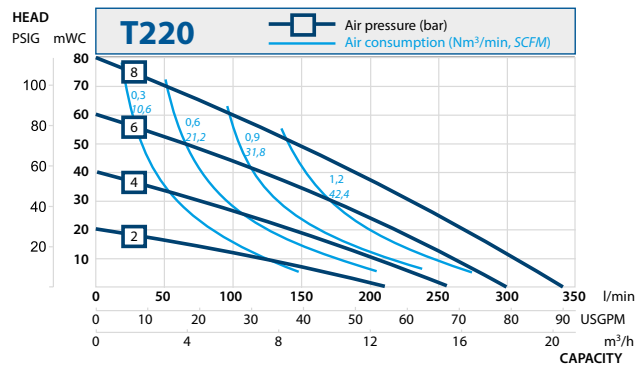
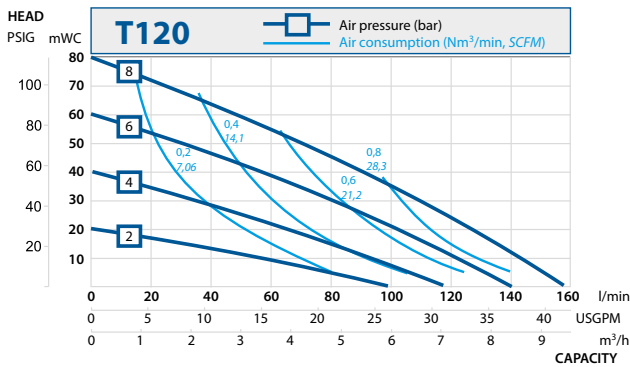
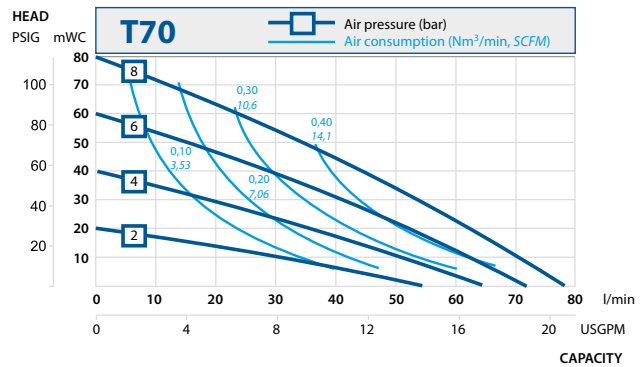
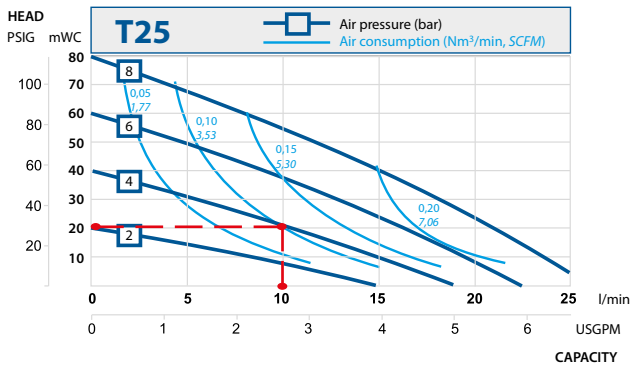

Capacity changes

Capacity changes at different suction lifts

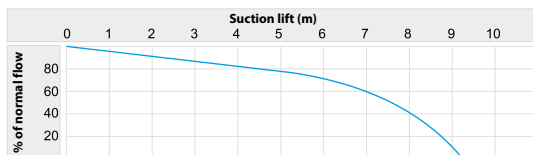

Capacity changes at different viscosities

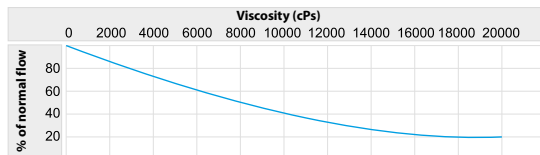

Changes reserved without notice

Dimensions

Aluminium and cast iron pumps T

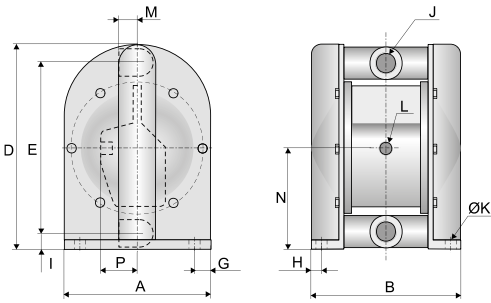

Stainless steel pumps T

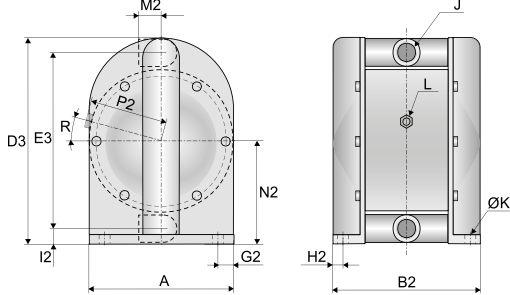

Drum pumps TD

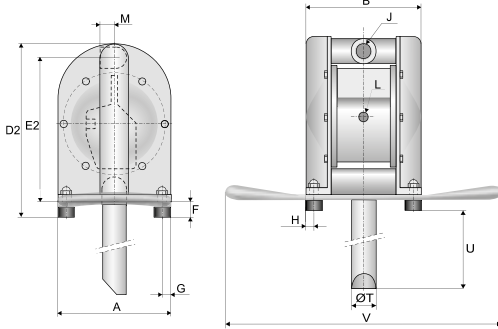

Twin pumps TT

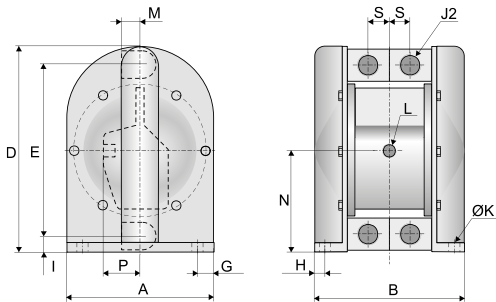

T820S

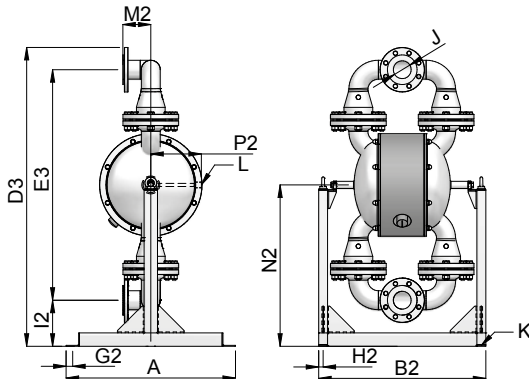

Dimensions for metal series

Dimensions in mm (where other is not indicated)

Dimensions in inch (where other is not indicated)

Dim	Pump size						
	25	70	120	220	420	820A**	820S***
A	105 4.13	150 5.91	200 7.87	275 10.83	356 14.02	470 18.50	760 29.92
B	117 4.61	167 6.57	198 7.80	267 10.51	342 13.46	488 19.21	-
B2	-	157 6.18	200 7.87	282 11.10	347 13.66	488 19.21	750 29.53
D	162 6.38	233 9.17	302 11.89	419 16.50	539 21.22	840 33.07	-
D2	173 6.81	249 9.80	322 12.68	-	-	-	-
D3	-	229 9.02	310 12.20	422 16.61	529 20.83	840 33.07	1341 52.80
E	132 5.20	190 7.48	252 9.92	346 13.62	448 17.64	688 27.09	-
E2	147 5.79	216 8.50	279 10.98	-	-	-	-
E3	-	192 7.56	257 10.12	348 13.70	443 17.44	-	1035 40.75
F	13 0.51	20 0.79	20 0.79	-	-	-	-
G	11 0.43	18 0.671	20 0.79	26 1.02	38 1.50	50 1.97	-
G2	-	17 0.67	20 0.79	31 1.22	36 1.42	-	25 0.98
H	12 0.47	19 0.75	20 0.79	29 1.14	30 1.18	53 2.09	-
H2	-	13.5 0.53	23.5 0.93	34 1.34	32 1.26	-	13 0.51
I	16 0.63	22 0.87	27 1.06	34 1.34	47 1.85	82 3.23	-
I2	-	19 0.75	27 1.06	38 1.50	44 1.73	-	206 8.11
J	1/2" 1/2	3/4" 3/4	1" 1	1 1/2" 1 1/2	2" 2	DN80(3") DN80(3")	-
J2	3/8" 3/8	1/2" 1/2	3/4" 3/4	1" 1	2" 2	-	-
ØK	6.5 0.26	10 0.39	10 0.39	10 0.39	10 0.39	12.5 0.49	25x13 1x0.5
L	1/8" 1/8	1/4" 1/4	1/4" 1/4	1/2" 1/2	1/2" 1/2	3/4" 3/4	3/4" 3/4
M	19 0.75	29 1.14	33 1.30	45 1.77	57 2.24	84.5 3.33	-
M2	-	40 1.57	52 2.05	70 2.76	90 3.54	-	126 4.96
N	82 3.23	117 4.61	153 6.02	207 8.15	274 10.79	356 14.02	-
N2	-	115 4.53	155 6.10	212 8.35	266 10.47	-	724 28.50
P	30 1.18	47 1.85	39 1.54	59 2.32	59 2.32	72.5 2.85	-
P2	-	82 3.23	105 4.13	143 5.63	183 7.20	-	238 9.37
R	-	15° 15°	15° 15°	0° 0°	0° 0°	-	0° 0°
S	12.5 0.49	21 0.83	26 1.02	35 1.38	420 1.57	-	-
ØT	20 0.79	30 1.18	30 1.18	-	-	-	-
U	1170* 46.06*	1170* 46.06*	1170* 46.06*	-	-	-	-
V	286 11.26	374 14.72	400 15.75	-	-	-	-

* = Any length up to 2000 mm on request

* = Any length up to 79" on request

** = Available in aluminium only

*** = Available in Stainless Steel only

Technical data

Data	Pump size										
	25	70A	70S	120A	120S	220A	220S	420A	420S	820 A	820 S
General characteristics											
*Max capacity (l/min) / (US gpm)	26 / 6.8	78 / 20		158 / 41		330 / 87		570 / 150		820 / 216	
**Volume per stroke (ml) / (cu in)	45 / 2.8	105 / 6.4	101 / 6.2	272 / 16.6	304 / 18.6	884 / 53.9	962 / 58.7	2440 / 148.9	2480 / 151.3	4897 / 298.8	3452 / 210.7
Max discharge pressure (bar) / (psi)	8 / 116										
Max air pressure (bar) / (psi)	8 / 116										
*** Max suction lift dry (m) / (Ft)	1.5 / 5	3 / 9.8		4 / 13		4 / 13		4 / 13		5 / 16	
Max suction lift wet (m) / (Ft)	8 / 26	8 / 26		8 / 26		8 / 26		8 / 26		8 / 26	
Max size of solids (ø in mm) / (in)	3 / 0.12	4 / 0.16		6 / 0.24		10 / 0.39		15 / 0.59		13 / 0.51	
Max temp with EPDM/NBR (°C) / (°F)	80 / 176										
Max temp with PTFE (°C) / (°F)	110 / 230										
Weight											
Standard pump in alu (kg) / (lb)	2 / 4.4	5 / 11		8.65 / 19.1		18.1 / 39.9		36.8 / 81.1		101.5 / 223.8	
Standard pump cast iron (kg) / (lb)	4.1 / 9	9.9 / 21.8		17.6 / 38.8		33.4 / 73.6		71.4 / 157.4		-	
Standard pump in AISI 316 (kg) / (lb)	-	6.8 / 15		15.5 / 34.2		35.9 / 79.2		66.1 / 145.7		137 / 302	
Drum pump TD in alu (kg) / (lb)	3 / 6.6	7 / 15		10 / 22		-		-		-	
Drum pump TD in AISI 316 (kg) / (lb)	-	7.5 / 16.53		16 / 35.27		-		-		-	
Material of components											
Pump housing and all wetted metal details	aluminium and cast iron	aluminium, cast iron or stainless steel AISI 316L								aluminium or AISI 316L	
Centre block, alu and cast iron pumps	aluminium (standard) or cast iron										
Centre block, AISI 316L pumps	-	PP (standard), conductive PE or aluminium									
Diaphragms	NBR, FKM, PTFE, PTFE 1705B or EPDM										
Valve balls	NBR, PTFE, AISI 316L****, EPDM, polyurethane or ceramic*****										
Air valve	Brass / NBR (standard) or AISI 316L / FKM or PET / NBR (standard on TX820), PET/FKM										
Gaskets	Klingerseal/NBR (standard), Klingerseal/EPDM, Klingerseal/FKM, FEP/FKM (stainless steel pumps)										
Housing screws	Steel on aluminium and cast iron pumps, A4-80 on stainless steel pumps										
Diaphragm shaft	Stainless steel AISI 316L (TX25, T820) / 304L (T70 -T420)										
Drum handle (TD pumps)	Stainless steel AISI 316										

* = Recommended flow is half of the max flow, i.e. recommended flow for a T120 is 79 l/min (20.8 US gpm).

** = The value is based on pumps with PTFE diaphragms (other materials - please contact Tapflo). It should be remembered that the volume per stroke may vary depending on the pump's operating parameters.

*** = This is max value with stainless steel valve balls, other valve ball materials may reduce the suction. Please consult us.

**** = Not available on TX820.

Pump code

The pump code details the specification, maximum capacity and materials of the major components.



I. T = Tapflo diaphragm pump

II. Basic options:

B = Backup diaphragm system

D = Drum pump

F = Filter press pump

L = Valve lift system (drain system)

P = Powder pump

T = Twin pump (double in/outlet)

X = ATEX approved, group II, cat 2 (zone 1)

Z = ATEX approved, group II, cat 1 (zone 0)

III. Pump size

IV. Material of wetted metal parts:

A = Aluminium

C = Cast iron

S = Stainless steel AISI 316

X = PTFE coated aluminium

V. Material of diaphragms:

B = PTFE TFM 1705B (solvents)

E = EPDM

N = NBR (nitrile rubber)

T = PTFE

V = FKM

W = White (food grade) EPDM

Z = PTFE with white back (food grade)

VI. Material of valve balls:

B = PTFE TFM 1635

E = EPDM

N = NBR (nitrile rubber)

T = PTFE

S = AISI 316 stainless steel

U = PU (polyurethane)

K = Ceramic

V = FKM

* = Ask us for complete pump code with all available options and executions. Changes reserved without notice

Sanitary series pumps

Hygienic design - made from electropolished stainless steel AISI 316L to meet the requirements in hygienic installations.



The Tapflo sanitary series is particularly designed to meet the requirements of the food, beverage, pharmaceutical and cosmetic industries.

Lubrication free air distribution system, maintenance free ball check valve system and total visual inspection of the wetted parts are some of the major features for this pump series.

The materials used on certain models comply with the FDA guidelines.

Models with extra fine internal surface finish $Ra < 0.8$ and $Ra < 0.5$ are available upon request.



EN 10204



The sanitary pump range

- » T30 - 28 l/min, 1"
- » T80 - 78 l/min, 1"
- » T125 - 155 l/min, 1 1/2"
- » T225 - 330 l/min, 2"
- » T425 - 570 l/min, 2 1/2"
- » T825 - 820 l/min, 3"

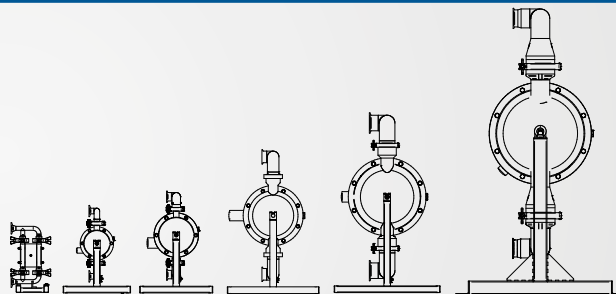

Typical applications

Sector	Example of applications
» Dairy products	Milk, cream, yogurt, cream cheese, melted cheese
» Grocery	Ketchup, mayonnaise, tomato products, mustard
» Beverages	Flavors, coloring, fruit juice
» Bakery	Dough, ingredients
» Brewery	Beer, flavors, coloring, wort
» Hygiene	Soap, shampoo
» Cosmetics	Cream, alcohols, perfume

The sanitary design

Made to be clean

Quick dismantling

The clamp system ensures quick and easy dismantling without any tools

Pollution free air valve

The sealing system is lubrication free, always keeping your product and environment free from oil contamination.

Variety of connection types

The pump is supplied as standard with SMS3017/ ISO2037 clamp connections. However, the pump may be equipped with almost any type of connection used in the hygienic field – DIN 11851 thread, SMS 1145 thread, DIN 11864 aseptic connections to mention a few.

Plain surface

The sandwich diaphragm has a completely plain surface, which eliminates bacteria growth problems. The diaphragm is available in food grade materials - PTFE, white EPDM or NBR FDA.

Superior finish

Both liquid side and outside is electropolished, to obtain superior finish and hygiene. Special surface finish may be done according to your requirements.

Easy draining

Drain the pump by turning the pump in its support (T80-T825)

Our design allows for total visual inspection of the wetted parts. There are no hidden areas where bacteria can grow. The manifold clamps and the housing screws are simply removed for complete disassembly and cleaning. The pump is also designed for cleaning and sterilization in place – C.I.P. and S.I.P. After such operations, the pump is easily turned in its support for drainage.



Special versions



Heating jacket

The heating jacket is used when the pumped product has to maintain a specific temperature, high or low, throughout the process. A heating or cooling medium is continuously circulated in the heating jacket. The jacket is covering all the wetted parts of the pump.

» Available for sizes: T80, T125, T225, T425



Flap valves for big solids

Flap valves are available for the sanitary pumps, ideal in applications with bigger size and delicate solids.

The gentle pumping principle will maintain solids without any destruction.

Models available with flap valves:

- » T80 (max 17 mm solids)
- » T125 (max 18 mm solids)
- » T225 (max 42 mm solids)
- » T425 (max 44 mm solids)
- » T825 (max 95 mm solids)

Magnetic ball lifters

» Available for sizes: T80, T125, T225

Magnetic ball lifters are implemented in Sanitary AODD pumps, to enable pump emptying without removing it from the installation when no other draining option is available. Rotating the pump is no longer needed.



Counter-connections

In order to ease the pump connection with installation Tapflo has added a full range of counter-connections to sanitary pumps. They fit pumps with standard tri-clamp connection as well as optional DIN11851 and SMS 1145 connections.

Performance curves

The performance curves are based on water at 20°C. Other circumstances might change the performance. See below how the capacity will change at different viscosities and suction lifts. These curves are valid for all sanitary pumps.

Example see the red line 

A flow of 25 litre/minute is desired.

The discharge head is calculated to 25 mWC. We choose a T80. It requires an air pressure of 4 bar and will consume approximately 0.20 Nm³/minute.

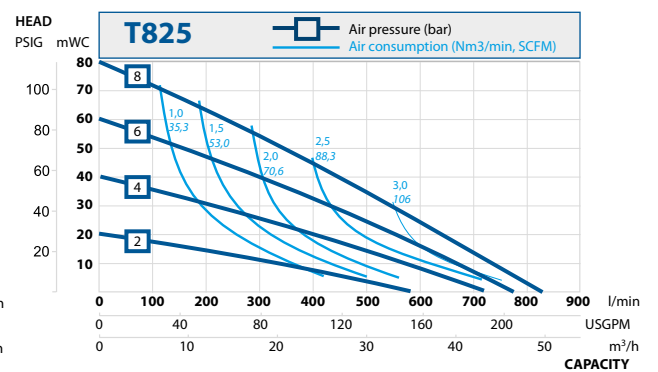
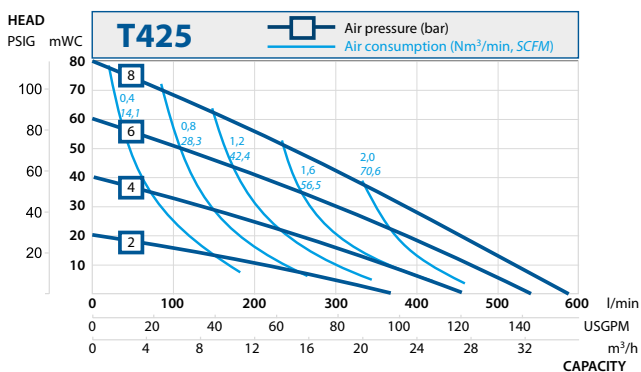
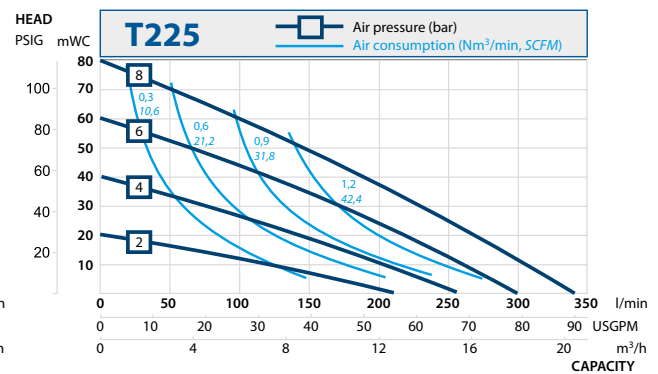
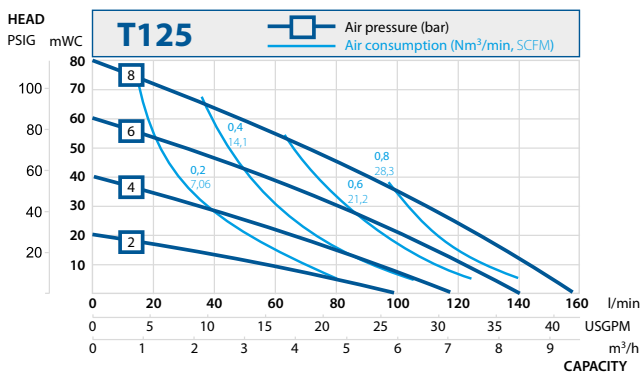
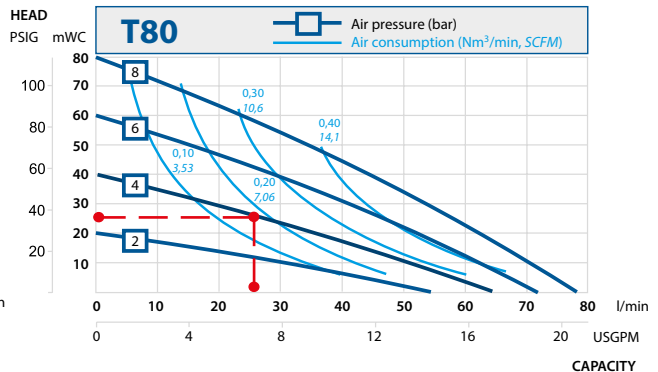
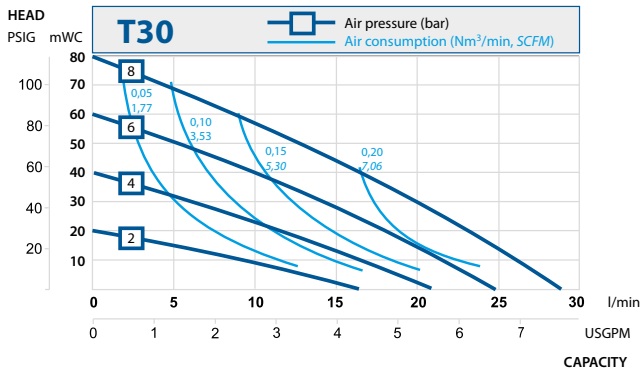

Recommended flow is half of the max flow, i.e. recommended flow for a T80 is 40 l/min (10.6 US gpm).

Capacity changes

Capacity changes at different suction lifts

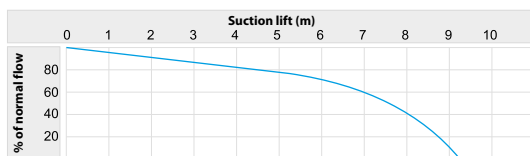

Capacity changes at different viscosities

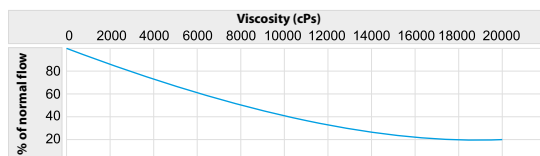

Changes reserved without notice

Dimensions

Dimensions for sanitary series

Dimensions in mm (where other is not indicated)

Dimensions in inch (where other is not indicated)

T30

T80-T825

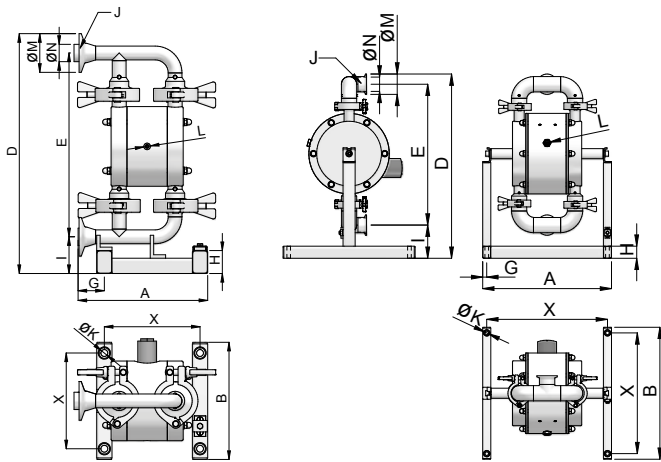

* = Dimensions for standard clamp connections only

1 = Clamp connections/pipes according to SMS3017/ ISO2037 (T425, T825)

2 = Threaded connections according to DIN 11851

3 = Threaded connections according to SMS 1145

Dim	Pump size						
	30	80	125	225	425	825	
A	169	295	320	404	468	750	
	6.7	11.6	12.6	15.9	18.4	29.5	
B	153	303	328	412	476	760	
	6.0	11.9	12.9	16.2	18.7	29.9	
D	313	393	458	647	808	1288	
	12.3	15.5	18.0	25.5	31.8	50.7	
E	240	294	350	528	664	1034.5	
	9.4	11.6	13.8	20.8	26.1	40.7	
G	34	10	10	10	10	20	
	1.3	0.4	0.4	0.4	0.4	0.8	
H	30	30	30	30	30	60	
	1.2	1.2	1.2	1.2	1.2	2.4	
I	48	74.5	82.5	86.5	98.5	206.5	
	1.9	2.9	3.2	3.4	3.9	8.1	
J	TC ¹	DN25	DN25	DN38	DN51	DN70	DN76.1
	DIN ²	DN20	DN25	DN40	DN50	DN65	DN80
	SMS ³	25	25	38	51	63.5	76.1
	RJT	3/4"	1"	1 1/2"	2"	3"	3 1/2"
ØK	9	9	9	9	9	25x13	
	0.4	0.4	0.4	0.4	0.4	1x0.5	
L	1/8"	1/4"	1/4"	1/2"	1/2"	1/2"	
ØM*	50.5	50.5	50.5	64	91	98	
	2.0	2.0	2.0	2.5	3.6	3.9	
ØN*	22.6	22.6	35.6	48.6	66.8	72.9	
	0.9	0.9	1.4	1.9	2.6	2.9	
X	125	275	300	384	448	710	
	4.92	10.83	11.81	15.12	17.64	27.95	

General dimensions only, ask us for detailed drawings.
Flap valve pumps are not shown here, ask us for drawings.

Technical data

Technical data	Pump size					
	30	80	125	225	425	825
Max capacity (l/min) / (US gpm)	28 / 7.4	78 / 20.6	155 / 40.9	330 / 87.2	570 / 150.6	820 / 216.6
*Volume per stroke (ml) / (cu in)	40 / 2.4	135 / 8.2	314 / 19.2	1000 / 61	2300 / 140.3	3281 / 200.2
Max discharge pressure (bar) / (psi)	8 / 116	8 / 116	8 / 116	8 / 116	8 / 116	8 / 116
Max air pressure (bar) / (psi)	8 / 116	8 / 116	8 / 116	8 / 116	8 / 116	8 / 116
**Max suction lift dry (m) / (Ft)	2 / 6.6	3 / 9.8	4 / 13	5 / 16	5 / 16	4 / 13
Max suction lift wet (m) / (Ft)	8 / 26	8 / 26	9 / 29.5	9 / 29.5	9 / 29.5	9 / 29.5
Max size of solids (ø in mm) / (in)	3 / 0.12	4 / 0.16	6 / 0.24	10 / 0.39	15 / 0.59	20 / 0.59
Max temperature (°C) / (°F)	110 / 230	110 / 230	110 / 230	110 / 230	110 / 230	110 / 230
Weight (kg) / (lb)	4 / 9	8 / 18	11 / 24	21 / 46	35 / 77	133 / 293

Wetted metal details	Stainless steel AISI 316L electro polished					
Centre block (not wetted)	PP, PE conductive					
Diaphragms	PTFE, PTFE with white back, EPDM, white EPDM, white NBR					PTFE EPDM
Valve balls	PTFE, AISI 316, PU, Ceramic, PE1000					
Air valve	Brass (std.), stainless steel AISI 316L or PET with NBR (std.), EPDM or FKM O-rings					
Gaskets	PTFE or EPDM					
Housing pin screws	Stainless steel					
Diaphragm shaft	Stainless steel AISI 316L (T30, T825) / 304L (T80 -T425)					

* = The value is based on pumps with PTFE diaphragms (other materials - please contact Tapflo). It should be remembered that the volume per stroke may vary depending on the pump's operating parameters.

** = This is max value with stainless steel valve balls, other valve ball materials may reduce the suction. Please consult us.

*** = Flap valve version. Theoretical max solid size, the actual size may vary depending on the shape. For more information contact us.

Pump code

The pump code details the specification, maximum capacity and materials of the major components.

I. II. III. IV. V. VI.
T J 80 S T T

I. T = Tapflo diaphragm pump

II. Basic options:

B = Backup diaphragm system

J = Pump with heating jacket

X = ATEX approved, group II, cat 2 (zone 1)

Z = ATEX approved, group II, cat 1 (zone 0)

III. Pump size:

IV. Material of wetted metal parts

S = stainless steel AISI 316L

V. Material of diaphragms:

B = PTFE 1705B (solvents)

E = EPDM

W = White food grade EPDM

N = NBR (nitrile rubber)

T = PTFE

Z = PTFE with white back (food grade)

VI. Material of valve balls:

E = EPDM

N = NBR (nitrile rubber)

T = PTFE

S = AISI 316L

U = PU (polyurethane)

K = Ceramic

B = PTFE TFM 1635

blank = flap valve version

* = Ask us for complete pump code with all available options and executions. Changes reserved without notice

Aseptic series pumps

Keeping your process clean



Tapflo Aseptic series pumps are designed for service in pharmaceutical-, biotech- and food industries where a clean process is the key.

Tapflo Aseptic series is EHEDG certified, has FDA and USP VI approved materials and conforms to the ATEX directive 2014/34/EU.

Typical applications

Industry	Example of applications
» Food & dairy	Soup, cream, syrup, dairy products, flavoring, alcohol, chocolate, paste
» Pharmaceuticals & cosmetics	Cream, paste, alcohol and filtration gel



EN 10204



Features & Benefits

✓ **No bacteria growth**
no horizontal areas inside the pump

✓ **No leakage**
no rotating shaft seals

✓ **Easy cleaning and draining**
designed for CIP and SIP cleaning

✓ **Flexible installation**
self-priming

✓ **Gentle pumping**
no damage of sensitive products

✓ **Reliable in service**
can run dry and against closed valve without damage

✓ **Wide range of connection types**
TriClamp, sanitary threads (DIN, SMS) etc.

✓ **Environmental friendly**
lube free air valve

✓ **Hygienic surfaces**
 housings made from electro polished stainless steel AISI 316L, Ra < 0.8 (standard) or Ra < 0.5 (on request)

✓ **Hygienic diaphragms**
designed without any nuts or plates on the pumped side

The EHEDG certificate



The EHEDG (European Hygienic Engineering & Design Group) certificate is your guarantee that the design is according to the hygienic guidelines. Furthermore the pump is cleanability tested, which means bacteria does not grow in the pump after cleaning and draining procedure.



Keeping your process clean

Smooth surfaces and cleanability are important keys for the EHEDG certification

Performance curves

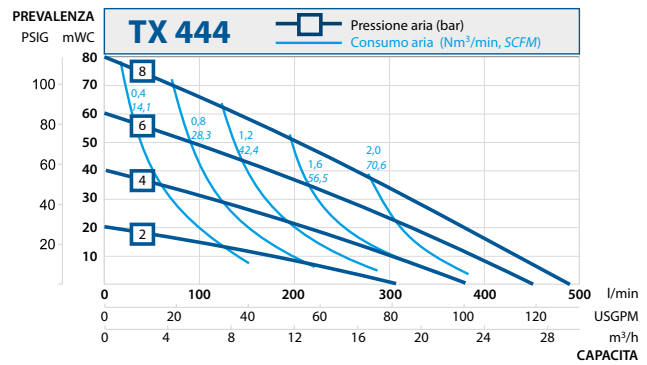
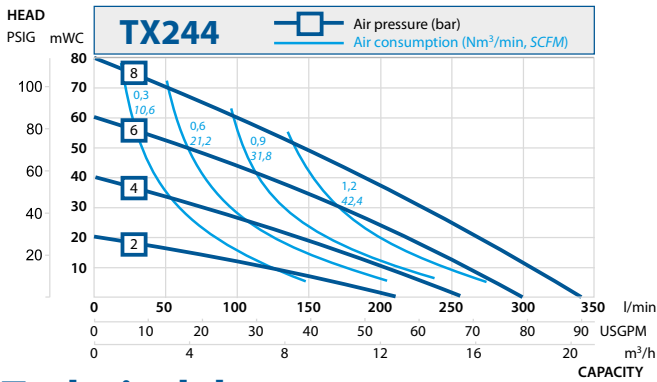
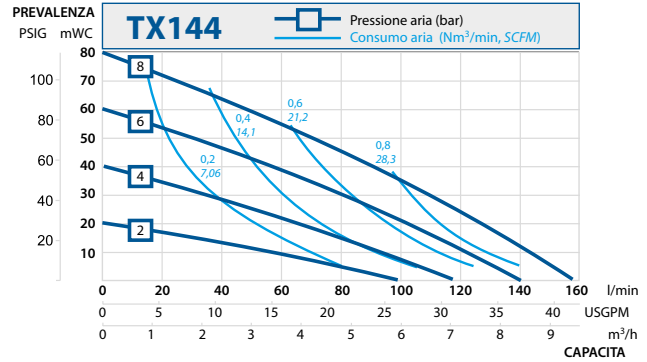
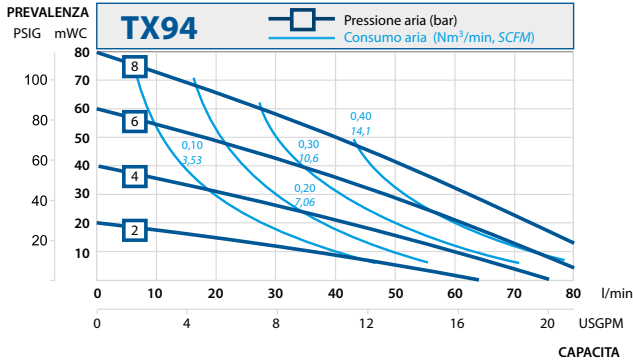

Technical data

Data	Pump size			
	TX94	TX144	TX244	TX444
General characteristics				
Max flow (l/min) / (US gpm)	94 / 25	144 / 38	270 / 71	360 / 95
*Volume per stroke (ml) / (cu in)	95 / 5.80	256 / 15.62	796 / 48.57	1922 / 117.29
Max discharge pressure (bar) / (psi)	8 / 16	8 / 16	8 / 16	8 / 16
Max air pressure (bar) / (psi)	8 / 16	8 / 16	8 / 16	8 / 16
**Max suction lift dry (m) / (Ft)	2 / 6.6	3 / 9.8	4.4 / 14.4	5 / 16
Max size of solids (ø in mm) / (in)	6 / 0.24	6 / 0.24	10 / 0.39	15 / 0.6
Max temperature (°C) / (°F)	-20° +110°C (temporarily higher)			
Weight (kg) / (lb)	15 / 33	22 / 48.5	50 / 110	107 / 236
Connections	DIN 32676 (standard), DIN 11864, DIN 11851			
ATEX details	TX pumps: Ex II 2G Ex h IIC T6...T4 Gb Ex II 2D Ex h IIIC T60°C...T125°C Db		TZ pumps: Ex II 1G Ex h IIC T6...T4 Ga	
Material of components				
Housing, manifolds	AISI 316L, Ra < 0.8, Ra < 0.5 on request			
Diaphragms	PTFE (FDA & USP VI), PTFE 1705B (solvents, FDA & USP VI)			
Valves (ball type)	PTFE (FDA), PTFE (USP VI & FDA), AISI 316L			
O-rings	EPDM (FDA), EPDM (USP VI & FDA), FEP/FKM (FDA), FKM			
Options	Backup diaphragm system, Magnetic ball lifters			

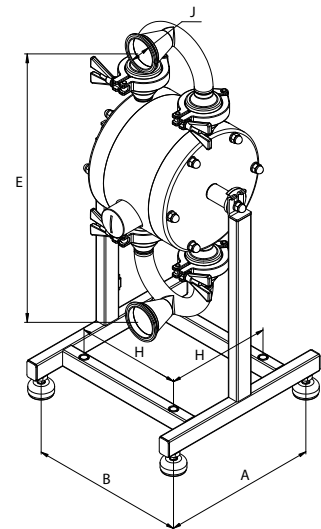

Dim	Pump size			
	TX94	TX144	TX244	TX444
A	278	278	360	433
B	278	278	360	433
E	457	488	700	885
H	188	188	270	331
J	DN 40	DN 50	DN 65	DN 80

*= The value is based on pumps with PTFE diaphragms (other materials - please contact Tapflo). It should be remembered that the volume per stroke may vary depending on the pump's operating parameters.

**= This is max value with stainless steel valve balls, other valve ball materials may reduce the suction. Please consult us.

Dimensions in mm (where other is not indicated)

Intelligent pumps - TC series



TC Intelligent pumps are fitted with ingenious LEAP® technology developed by Tapflo.

LEAP® or 'Low Energy Air Pump' is a patented technology used in AODD pumps to reduce the minimum operating air pressure by reducing internal losses and friction found in conventional AODD pumps.

LEAP uses a unique indirect system to detect the position of the diaphragm shaft controlling the diaphragm movement automatically.

Features & Benefits

- ✓ **Available in Plastic, Metal and Sanitary series AODD pumps**
 TC50 - TC425 (T50 - T425 equivalent)
- ✓ **Noise Reduction**
 ability to utilise lower air pressure reduces the noise of the pump
- ✓ **Retrofit**
 Leap can be fitted to any existing Tapflo Air Operated Diaphragm Pumps
- ✓ **Electrical feedback**
 signal allows for external monitoring of the pump process.
- ✓ **Batch Dispensing**
 allowing the pump to automatically stop after the required volume has been dispensed.
- ✓ **Improved Maintenance**
 main air valve can be changed in under two minutes without the removal of the pump from the process line.
- ✓ **Improved Lifespan**
 the TC series uses an air valve that has a significantly longer life expectancy over rubber seal technology.
- ✓ **Control Simplification**
 no need for an external pneumatic solenoid valve, reducing costs and simplifying control.
- ✓ **Dry Running**
 by analysing the frequency of pulses, the pump can analyse when it is running dry.
- ✓ **Dead Heading**
 as with dry running, the frequency of pulses can be monitored, alerting if the pump has a blockage.

Graph showing fluid flow against air pressure required

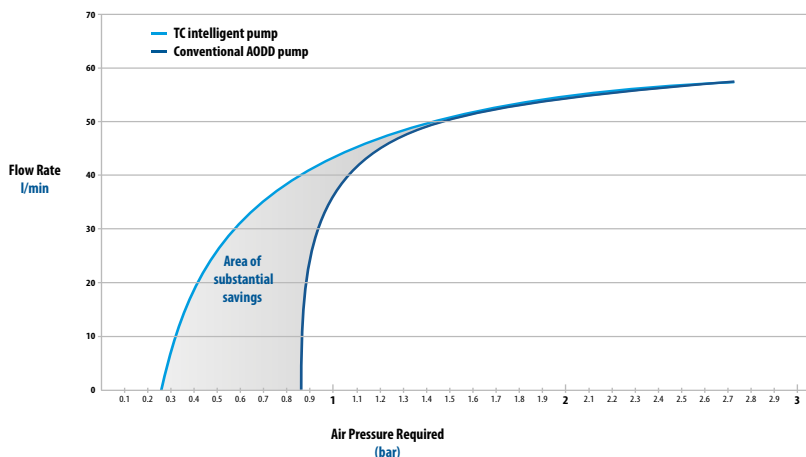

The pump fitted with LEAP® Technology is able to **start pumping at 0.3 bar without stalling**, in test the pump was already achieving flow rates of **70% of its maximum open end flow before other pumps had even started.**

Filter press pumps - TF series

The Tapflo pump station for filter press feeding is a very compact unit that can be mounted directly to the filter press.



TF series

The design and function allows the user a straightforward pressing of slurries. Pressure regulator is already mounted to the unit.

An external pressure booster doubles the delivery pressure. For example, with available air pressure of 7 bar, the delivery pressure will be maximum 14 bar.

TF pumps are based on standard Tapflo AODD pump design

PE & FTFE: TF 50 | TF 100 | TF 200 | TF 400

Metal pumps: TF 70 | TF 120 | TF 220 | TF 420

Features & Benefits

- ✓ Can run dry
- ✓ Self priming
- ✓ High pressure transmission up to 1:2
- ✓ Few parts – easy to maintain
- ✓ Long service life
- ✓ Reliable and compact

The Installation

Adding a pump to an existing filter press was never such easy. The pump is already equipped with a pressure booster, manometers, regulation knob and all essential hoses and fittings.

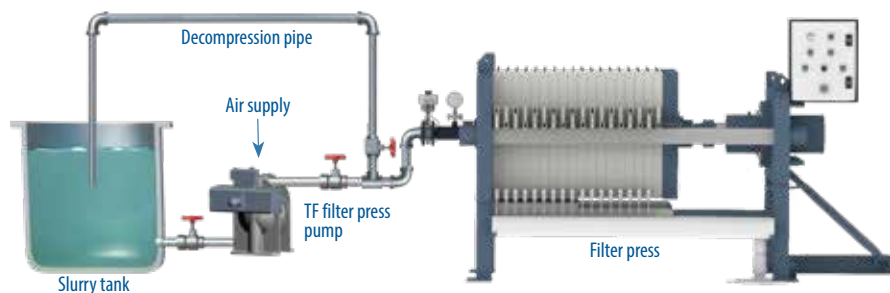

Technical data

Pump size	Connection size (" BSP or NPT)	*Max capacity (l/min) / (US GPM)	Max pump pressure (bar) / (PSI)
TF 50 TF 70	1/2" 3/4"	*60 / 15.8 78 / 20	16 / 232
TF 100 TF 120	1"	*125 / 33 158 / 41	16 / 232
TF 220 TF 420	1 1/2" 2"	*330 / 87 570 / 150	14 / 203
TF 200 TF 400	1 1/2" 2"	*330 / 87 570 / 150	12 / 174

* = This max flow is obtained when using a bypass round the pressure booster at low pressure

Powder pumps - TP series



Reduced contamination

The powder is transferred in a hermetic system from the powder container to your process.

Economical and compact solution

The Tapflo powder transfer pump can do the same job as many complex and large powder systems. The compact design also makes the unit portable.

What kind of powders?

The powder transfer pump will handle different types of process powders, with specific weight from 80 up to 720 kg/m³ dry weight. Generally, if the powder does not clump together when squeezed in hand, the Tapflo powder transfer pump can be used successfully. A few examples of common powders are *sintering powder, carbon black, resins and silicones*.

Capacity

The capacity of the powder transfer is extremely different from one powder to another, depending on the consistency and weight etc.



EN 10204



Working principle

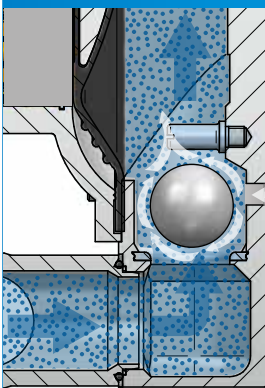

No start up problems

The air induction system eliminates powder pack up problems when starting the pump.

Air is induced to the powder side of the pump for diffusion of the powder. The induction flow can manually be adjusted by means of a needle valve to obtain a optimum performance.

Features & Benefits

- Economical**
compared with other complex powder systems
- Convenient**
and safer than manual powder handling

Technical data

Model	TXP70	TXP120	TXP220	TXP420	TXP820
In/outlet connections	3/4" BSP thread (NPT on request)	1" BSP threads (NPT upon request)	1 1/2" BSP threads (NPT upon request)	2" BSP threads (NPT upon request)	3" BSP threads (NPT on request)
Features	Complete air induction system included				
Explosion protection	ATEX marked according to group IIG (gas) / IID (dust), category 2				
Housing material	PTFE coated aluminium				
Diaphragm material	EPDM, NBR, PTFE				
Valve ball	EPDM, NBR, AISI 316L, PU				
In/outlet material	Stainless steel AISI 316L or PTFE coated aluminium				

Pharmaceutical pumps - 5UVI series

USP VI approved pharmaceutical series air driven pump for pharmaceutical and biotech industries



This pump series was developed in co-operation with one of the world leading supplier to the biotech market. It serves the biotech- and pharmaceutical industries in numerous applications.

Our unique USP approved (United States Pharmacopoeia) hygienic PTFE or PP pump, features all wetted parts in USP class VI certified materials.

Simplicity

Pump housing with only three parts makes it extremely easy to maintain.

Superior finish

High finish and hygienic approved materials.



EN 10204



The Pharmaceutical series pumps

- | | |
|--------|-----------------|
| » T53 | 60 l/min; ¾" |
| » T103 | 125 l/min; 1" |
| » T203 | 330 l/min; 1 ½" |
| » T403 | 570 l/min; 2" |

Features & Benefits

- ✓ Sanitary design
smooth internal surfaces
- ✓ Inert materials
no contamination of the pumped product
- ✓ USP class VI
approved materials
- ✓ Extremely easy to maintain
pump housing with very few components

Active pulsation dampeners

The Tapflo pulsation dampener works actively with compressed air and a diaphragm, automatically setting the correct pressure to minimise the pulsations.



The active pulsation dampener is the most efficient way to remove pressure variations on the discharge of the pump.

The Tapflo pulsation dampener works actively with compressed air and a diaphragm, automatically setting the correct pressure to minimise the pulsations.

Explosion proof models are available
 Certified according to directive 2014/34/EU (ATEX), group II, cat 2, for use in EX-zone 1. **Contact us for information.**



EN 10204



Working principle

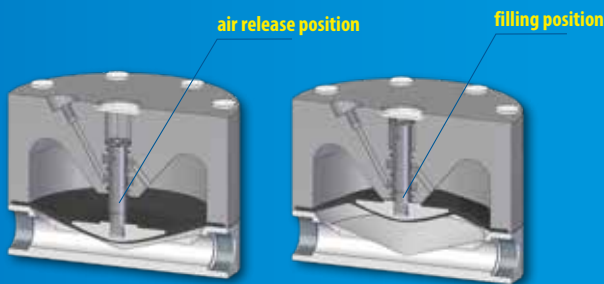

When the pressure in the piping system decreases, due to the pulsating nature of the pump operation, the pulsation dampener eliminates pressure peak to the discharge between the pump strokes, therefore supplying a steady flow of pumped medium. This pumping action created by the dampener, decreases the pressure variations and pulsations.

Features

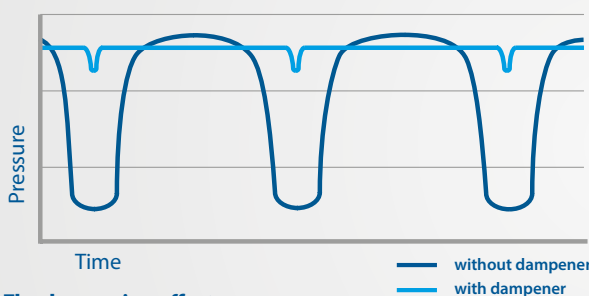

The dampening effect

The pressure variation in a discharge line with and without a pulsation dampener.

- ✓ Minimized vibrations and water hammer effects
- ✓ Protection of all kinds of instruments in your pipe system
- ✓ Optimized pump performance and reduced maintenance costs
- ✓ Minimum air consumption
- ✓ Reduced pressure peaks

Options & accessories



Pulsation dampener with stand



Pulsation dampener with pump



Pulsation dampener with guardian



DTK – dampener designed to be built on pump

Systems & accessories

Guardian systems



The Guardian is an energy conservation device designed to protect an air operated double diaphragm (AODD) pump from operating in an inefficient manner that uses unnecessary energy and reduces the life of its parts. It also offers the added benefit of providing greater safety to applications of high risk.

The Guardian directly monitors the discharge fluid pressure against its set point stopping the pump if the media pressure increases above the set point (closed valve) or falls below the set point (dry-run) dependant on configuration.

Applications of Guardian systems

Barrier Protection

Barrier pumps (TB) have an additional set of diaphragms used to back-up the primary diaphragms. In case of a breach the liquid remains inside the pump, instead of leaking out through the air exhaust. The Guardian monitors the pressure between the primary and secondary diaphragms, stopping the pump if the pressure increases above the set point.



Dry run & stop

The Guardian monitors the fluid discharge pressure of the pump, stopping it if the pressure falls below the set point, caused by a lack of media on the suction causing air to be ingested into the pump.

Dead head & stop

The Guardian monitors the fluid discharge pressure of the pump, stopping it if the pressure rises to the set point, caused by a closed valve or over pressure in the discharge line.



Dead head & restart

The Guardian monitors the fluid discharge pressure of the pump, stopping it if the pressure rises to the set point, caused by a closed valve or over pressure in the discharge line. When the pressure falls below the set pressure, the pump automatically restarts.

Control systems



Pneumatic batch control

Pneumatic batcher can control any Tapflo AODD pump to deliver accurate and repeatable volumes. Fully programmable allowing you to set the batch amount (TPUK-BP) or batching time (TPUK-BT).

Pneumatic level control

A fully pneumatic automatic level system used to maintain set liquid levels within a sump or tank.

Stroke counter / low pressure VFC

A stroke to volt free contact (VFC) is available for integration with PLC systems. Simply connect to any AODD pump via the air exhaust muffler to monitor the pump strokes.

Life counter

Tapflo's life counter simply connects to the AODD pump air exhaust, representing the strokes on the LCD display. Compact, easy to use and cost effective this simple system will allow you to control servicing and implement a preventative maintenance routine.

Mobile solutions for pump units and systems

Mobile pump units are found as the best solution for the users of spread technological processes. The portability of the Units allows easy movement to various locations. This means almost limitless application.



Trolley S | 2-wheel

Tapflo standard AODD pumps with capacity up to 125 l/min (pump sizes: up to 100/120, except T80),



Trolley M | 4-wheel

Tapflo standard AODD pumps with capacity up to 570 l/min (pump sizes: up to 400/420, except T425),



Hygienic trolley

Hygienic trolleys offered by Tapflo are available in two sizes. M Trolleys are used for standard pumps up to T425. L Trolleys are used for pump dampener assemblies.

For further details, please check the separate brochure systems & accessories for pumps

Filter regulator & needle valve kit



There are many benefits of using an individual filter regulator and needle valve for your AODD pump. You will always be able to run the pump with right air quality and optimum pressure and speed to save energy. Furthermore the lifetime of pump components will increase. The kit includes a filter regulator, gauge, wall bracket, needle valve, and/ or water separator. The filter is 5 micron and regulator is 0-12 bar, available in sizes 1/8" up to 3/4".

Pneumixer



The Pneumixer was initially developed for the paint and ink industry where most raw materials in drums or containers settle out over time and need to be mixed or blended prior to use. This usually means rolling, shaking or pumping to a mixing vessel; that adds time, waste, mess and expense.

Features & Benefits

- ✓ No paddles
- ✓ No rotating blades
- ✓ Variable agitation
- ✓ Suits all containers up to 1000 litre IBC
- ✓ No moving parts utilises pump power to mix & dispense
- ✓ Eliminates problems with conventional mixing
- ✓ No air entrainment
- ✓ No shear
- ✓ Closed vessel mixing system
- ✓ Fully controllable pneumatic operation and control
- ✓ Reduced environmental exposure
- ✓ No need for pumping to mixing vessel

